



MARQUE: TEFAL
REFERENCE: FF2308 PRiNCiPiO
CODiC: 4398530



NOTICE



principio

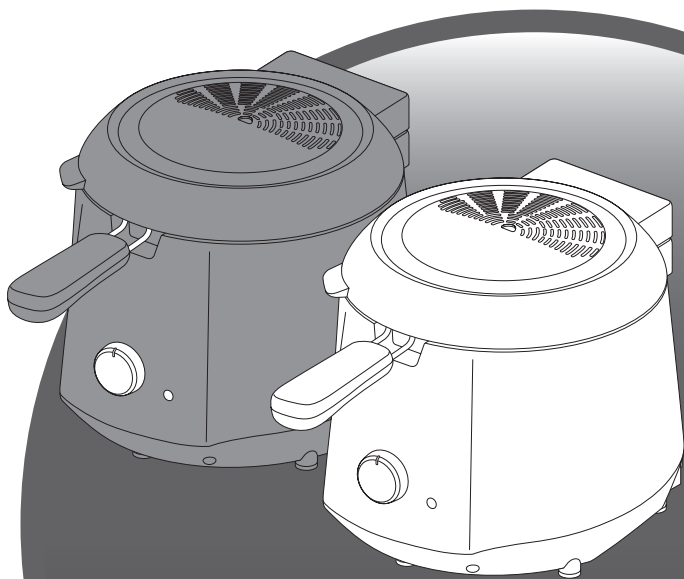

www.groupeseb.com

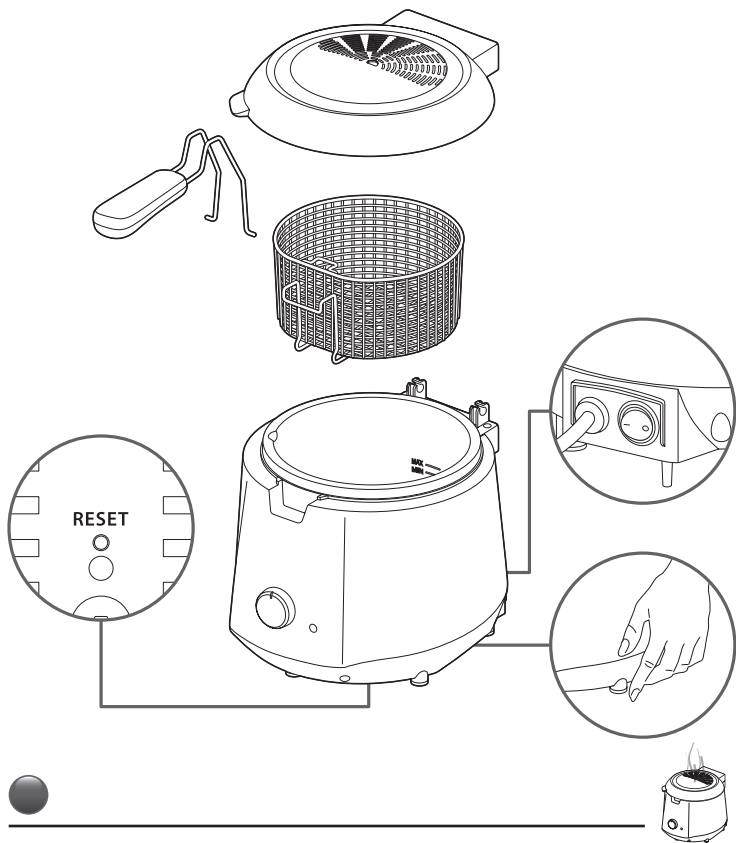

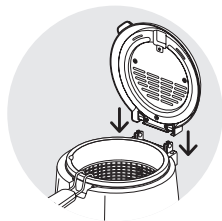
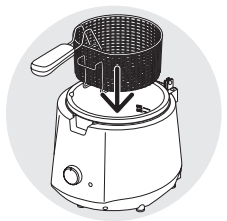
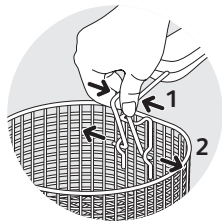
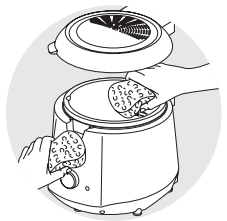
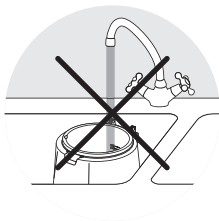
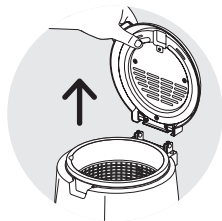
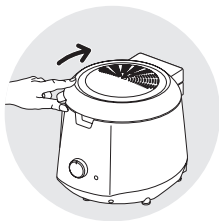
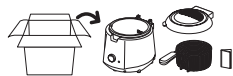



Min 1 L
Max 1.2 L

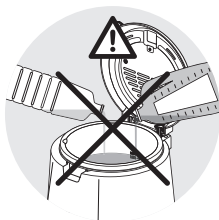
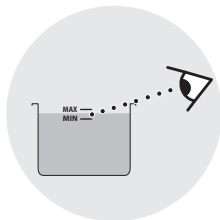
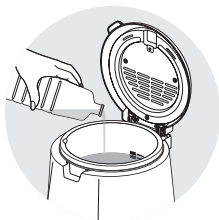



Max 600 g
 Max 400 g





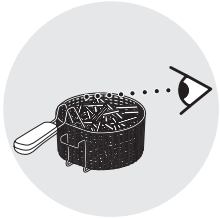
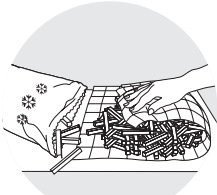

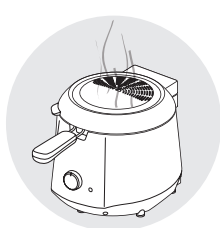
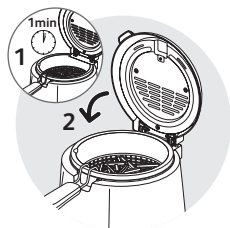
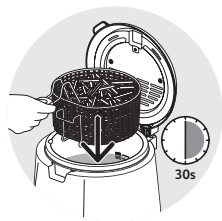
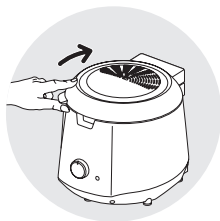
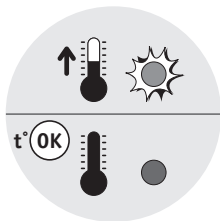
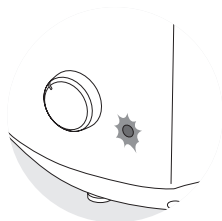
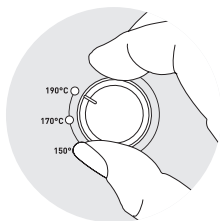
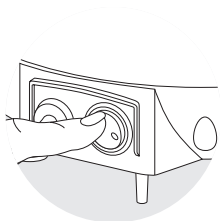
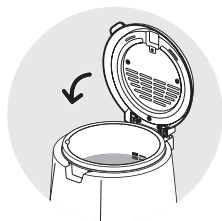











Max 500 g
 Max 250 g







	Nb		 °C	
		600 g	190°C	13-16 min
		400 g	190°C	11-13 min
		50 g	170 °C	2-4 min
***	Nb		 °C	
		500 g	190°C	11-13 min
		250 g	190°C	7-9 min
		500 g	190°C	4-6 min
		500 g	170°C	4-6 min

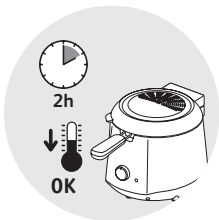
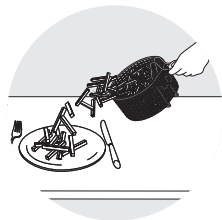
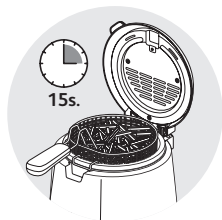
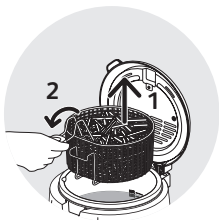
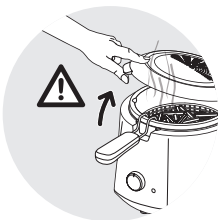
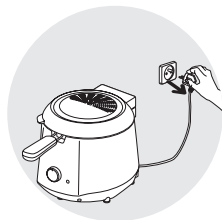
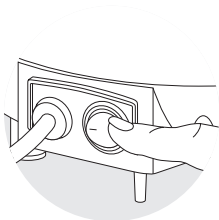
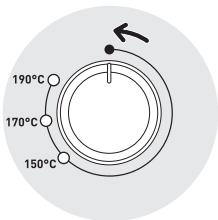

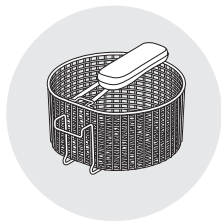
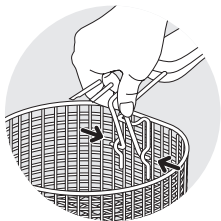
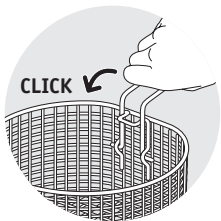
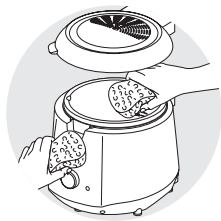
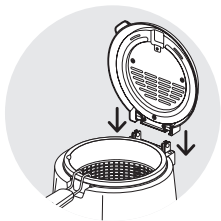
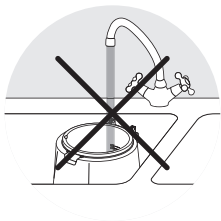
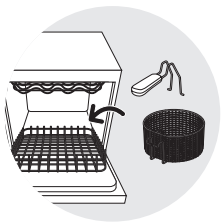
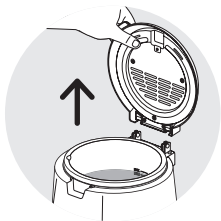
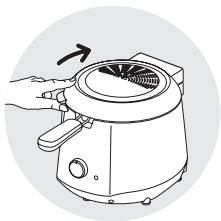

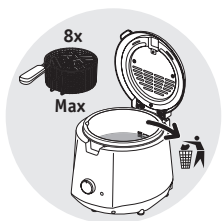
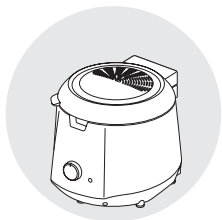

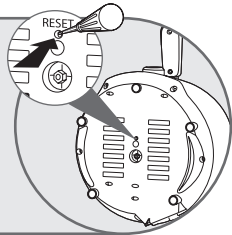
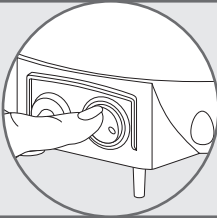
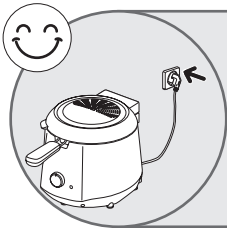
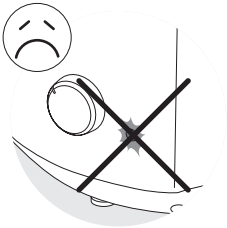

NC00136974