

SAMSUNG

MICROWAVE OVEN

BASIC MODEL : GE83KRQW-1/BW

MODEL : MG23J5133AK

MODEL CODE : MG23J5133AK/EF

SERVICE *Manual*

MICROWAVE OVEN



CONTENTS

1. Precaution
2. Product Specification
3. Disassembly and Reassembly
4. Troubleshooting
5. PCB Diagrams
6. Wiring Diagrams
7. Schematic Diagrams

• Contents

1. Precaution	3
1-2 Special High Voltage Precautions	5
2. Specifications	6
2-1 Features	6
2-2 Table of Specifications	7
2-3 Accessory	8
3. Disassembly and Reassembly	9
3-1 Tool for assembly and disassembly	9
3-2 Disassembly of Magnetron, Motor Assembly and Lamp	10
3-3 Replacement of High Voltage Transformer	13
3-4 Replacement of Door Assembly	15
3-5 Replacement of Drive Motor	16
3-6 Replacement of Control Circuit Board	17
3-7 Replacement of Grill heater	18
4. Troubleshooting	19
4-1 Parts checking method	19
4-2 Information Code Numbering Rule	20
4-3 Information Code List	21
4-4 Electrical Malfunction	22
5. PCB Diagrams	25
5-1 PCB Diagrams	25
7. Schematic Diagrams	29
7-1 Schematic Diagrams	29

1. Precaution



PRECAUTIONS TO BE OBSERVED BEFORE AND DURING SERVICING TO AVOID POSSIBLE EXPOSURE TO EXCESSIVE MICROWAVE ENERGY

- (a) Do not operate or allow the oven to be operated with the door open.
- (b) Make the following safety checks on all ovens to be serviced before activating the magnetron or other microwave source, and make repairs as necessary:
 - (1) Interlock operation,
 - (2) Proper door closing
 - (3) Seal and sealing surfaces (arcing, wear, and other damage),
 - (4) Damage to or loosening of hinges and latches,
 - (5) Evidence of dropping or abuse.
- (c) Before turning on microwave power for any service test or inspection within the microwave generating compartments, check the magnetron, wave guide or transmission line, and cavity for proper alignment, integrity, and connections.
- (d) Any defective or misadjusted components in the interlock, monitor, door seal, and microwave generation and transmission systems shall be repaired, replaced, or adjusted by procedures described in this manual before the oven is released to the owner.
- (e) A Microwave leakage check to verify compliance with the Federal performance standard should be performed on each oven prior to release to the owner.

1. Precaution

Follow these special safety precautions. Although the microwave oven is completely safe during ordinary use, repair work can be extremely hazardous due to possible exposure to microwave radiation, as well as potentially lethal high voltages and currents.

1-1 Safety precautions ()

1. All repairs should be done in accordance with the procedures described in this manual. This product complies with Federal Performance Standard 21 CFR
 2. Microwave emission check should be performed to prior to servicing if the oven is operative.
 3. If the oven operates with the door open :Instruct the user not to operate the oven and contact the manufacturer and the center for devices and radiological health immediately.
 4. Notify the Central Service Center if the microwave leakage exceeds 5 mW/cm².
 5. Check all grounds.
 6. Do not power the MWO from a "2-prong" AC cord. Be sure that all of the built-in protective devices are replaced. Restore any missing protective shields.
 7. When reinstalling the chassis and its assemblies, be sure to restore all protective devices, including: nonmetallic control knobs and compartment covers.
 8. Make sure that there are no cabinet openings through which people --particularly children--might insert objects and contact dangerous voltages. Examples: Lamp hole,ventilation slots.
 9. Inform the manufacturer of any oven found to have emission in excess of 5 mW/cm² ,Make repairs to bring the unit into compliance at no cost to owner and try to determine cause. Instruct owner not to use oven until it has been brought into compliance.
- CENTRAL SERVICE CENTER**
10. Service technicians should remove their watches while repairing an MWO.
 11. To avoid any possible radiation hazard,replace parts in accordance with the wiring diagram. Also, use only the exact replacements for the following parts: Primary and secondary interlock switches, interlock monitor switch.
 12. If the fuse is blown by the Interlock Monitor Switch: Replace all of the following at the same time: Primary, door sensing switch and power relay, as well as the Interlock Monitor Switch. The correct adjustment of these switches is described elsewhere in this manual. Make sure that the fuse has the correct rating for the particular model being repaired.
 13. Design Alteration Warning: Use exact replacement parts only, i.e.,only those that are specified in the drawings and parts lists of this manual. This is especially important for the Interlock switches, described above. Never alter or add to the mechanical or electrical design of the MWO. Any design changes or additions will void the manufacturer's warranty. Always unplug the unit's AC power cord from the AC power source before attempting to remove or reinstall any component or assembly.
 14. Never defeat any of the B+ voltage interlocks. Do not apply AC power to the unit (or any of its assemblies) unless all solid-state heat sinks are correctly installed.
 15. Some semiconductor ("solid state") devices are easily damaged by static electricity. Such components are called Electrostatically Sensitive Devices (ESDs). Examples include integrated circuits and field-effect transistors. Immediately before handling any semiconductor components or assemblies, drain the electrostatic charge from your body by touching a known earth ground.
 16. Always connect a test instrument's ground lead to the instrument chassis ground before connecting the positive lead; always remove the instrument's ground lead last.
 17. When checking the continuity of the witches or transformer, always make sure that the power is OFF, and one of the lead wires is disconnected.
 18. Components that are critical for safety are indicated in the circuit diagram by shading,  or .
 19. Use replacement components that have the same ratings, especially for flame resistance and dielectric strength specifications. A replacement part that does not have the same safety characteristics as the original might create shock, fire or other hazards.
NOTE : Connect the oven to a 20A. When connecting the oven to a 15A,make sure that circuit breaker can operate.

1. Precaution

1-2 Special High Voltage Precautions

1. High Voltage Warning Do not attempt to measure any of the high voltages --this includes the filament voltage of the magnetron. High voltage is present during any cook cycle. Before touching any components or wiring, always unplug the oven and discharge the high voltage capacitor (See Figure 1-1)
2. The high-voltage capacitor remains charged about 30 seconds after disconnection. Short the negative terminal of the high-voltage capacitor to to the oven chassis. (Use a screwdriver.)
3. High voltage is maintained within specified limits by close-tolerance, safety-related components and adjustments. If the high voltage exceeds the specified limits, check each of the special components.

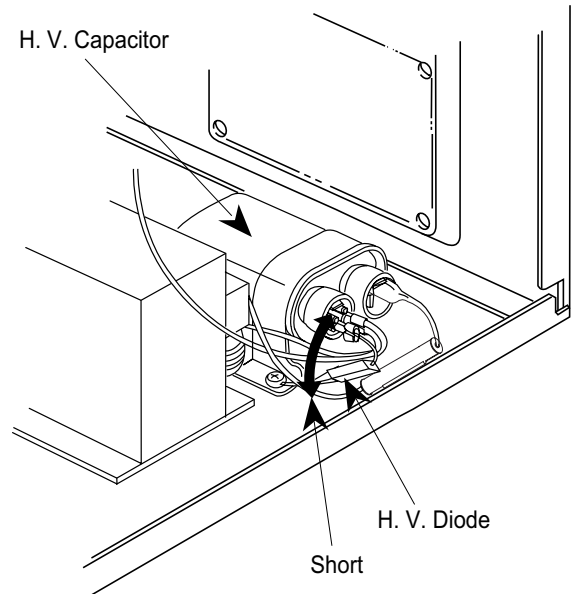

PRECAUTION

There exists HIGH VOLTAGE ELECTRICITY with high current capabilities in the circuits of the HIGH VOLTAGE TRANSFORMER secondary and filament terminals. It is extremely dangerous to work on or near these circuits with the oven energized.

DO NOT measure the voltage in the high voltage circuit including filament voltage of magnetron.



PRECAUTION

Servicemen should remove their watches whenever working close to or replacing the magnetron.



PRECAUTION

Never touch any circuit wiring with your hand nor with uninsulated tool during operation.

2. Specifications

2-1 Features

Features

■ Auto Cook Menu

Don't know how to cook? Samsung's new Microwave Oven auto cooking technology offers preset functions resulting in perfectly cooked dishes every time. Simply select a cooking menu, and the cooking results will astound you.

■ Ceramic Coating Cavity

The interior fully coated with Ceramic Enamel offers solid surface that never scratches and cracks. So you can enjoy the same new interior even after long use. Moreover, it prevents the bacteria and the sooth surface. It is easy to clean as well. The significantly higher cooking temperature and animal protein can cause severe discoloration and cleaning issue. But the Ceramic Enamel Interior prevents all of them.

■ Aesthetic Design

The Mirror exterior delivers a luxurious look to your kitchen. The design matches perfectly with your other kitchen appliances, providing a harmonious kitchen interior.

2. Specifications

2-2 Table of Specifications

Item		Basic	New	
		GE83KRQW-1/BW	MG23J5133AK/EF	
General	Capacity		23L	23L
	Power	Power Source	230V~50Hz AC	230V~50Hz AC
		Output Power(Microwave)	800W	800W
		Output Power(Grill)	1100W	1100W
		Power consumption(MW)	1200W	1200W
		Max Output Power	2300W	2300W
	Output Power		800W(IEC-705)	800W(IEC-705)
	Operation Frequency		2450MHz	2450MHz
	Type		CMO	CMO
	Display		LED	LED
	Control Method		MEMBRANE	MEMBRANE
	Door Open Mechanism		Push Button	Push Button
	MW Distribution Mechanism		SIDE FEEDING	SIDE FEEDING
	Volume		0.8 Cu.ft	0.8 Cu.ft
	Dimension	Outside	489 x 275 x 372mm	489 x 275 x 354mm
	(W x H x D)	Cavity	330 x 211 x 324mm	330 x 211 x 324mm
Weight	Net	12.5 kg	13.5 kg	
	Gross	14.0 kg	15.0 kg	
Export Zone		RUSSIA	FRANCE	
Feature	MWO Mode	1. MW	YES	YES
	Grill Mode	1. GRILL	YES	YES
	Combi Mode	1. MW + GRILL	YES(300W,450W,600W)	YES(300W,450W,600W)
	Auto Cook	1. RUSSIAN MENUS	YES(27)	YES(27)
		2. HEALTHY COOKING	YES(20)	YES(20)
		3. SOUP/DRINKS	YES(19)	YES(19)
		4. DEFROST	YES(RAPID 4)	YES(RAPID 4)
		5. SOFTEN/MELT	YES (4)	YES (4)
	Keep Warm		YES	YES
	ECO		YES	YES
	Clock		YES	YES
	Max time Cooking	MW	99 min	99 min
	Power Level		YES(6)	YES(6)
Setting	Sound Option	YES	YES	
	Clock System Option	24H+12H	24H+12H	
	Child Lock	YES	YES	
Material & Finishes	Outer Panel Color		WHITE	BLACK
	Door Color		WHITE	BLACK
	Cavity Interior		Ceramic Enamel	Ceramic Enamel
	Packing Case		ECO Box	ECO Box



2. Specifications

2-3 Accessory

Item	Description	Code NO.	Q'ty
	Assy-Guide Roller	DE97-00193D	1
	Tray-cooking	DE74-20102D	1
	Rack-Wire	DE74-70071D	1

3. Disassembly and Reassembly

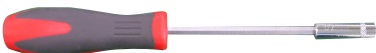
3-1 Tool for assembly and disassembly

Tool	Type	Remark
	7mm vox driver	
	Screwdriver	
	Nipper	

3. Disassembly and Reassembly

3-2 Disassembly of Magnetron, Motor Assembly and Lamp

Remove the magnetron including the shield case, permanent magnet, choke coils and capacitors (all of which are contained in one assembly)

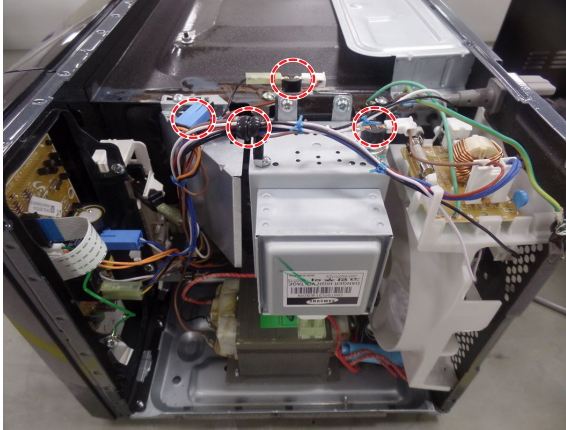
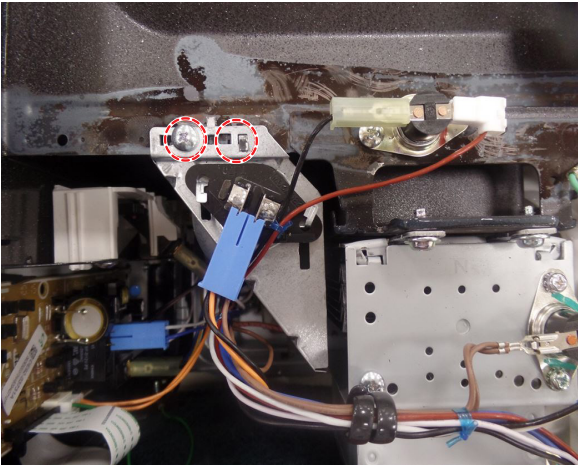
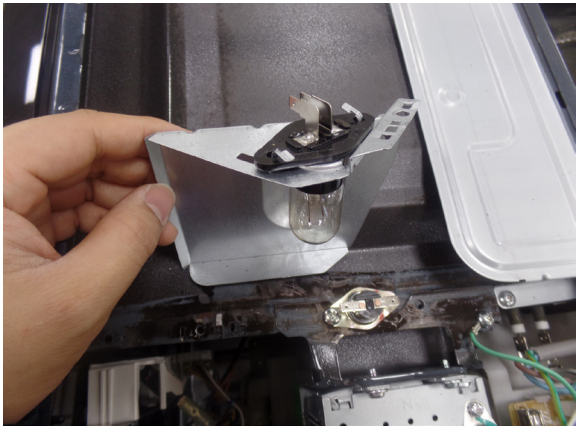
Parts	Explanation Photo	Explanation
Magnetron, Motor Assembly and Lamp		<ol style="list-style-type: none"> 1. Disconnect all lead wires from the magnetron and lamp.
		<ol style="list-style-type: none"> 2. Remove a screw securing air cover.
		<ol style="list-style-type: none"> 3. Remove the air cover.

3. Disassembly and Reassembly

3-2 Disassembly of Magnetron, Motor Assembly and Lamp

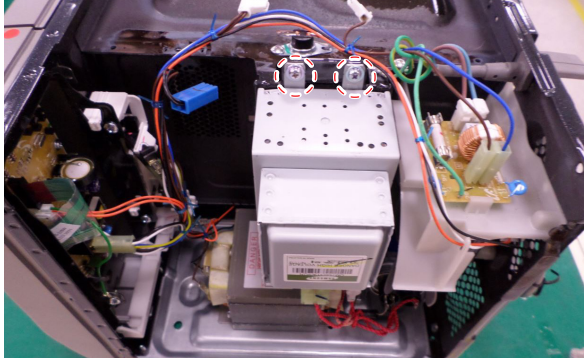
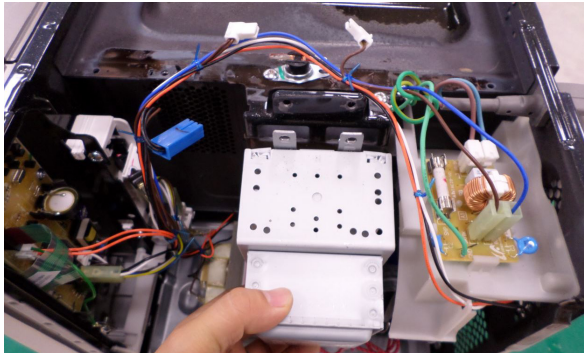
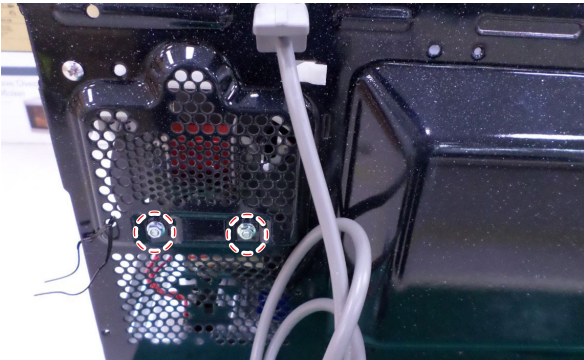
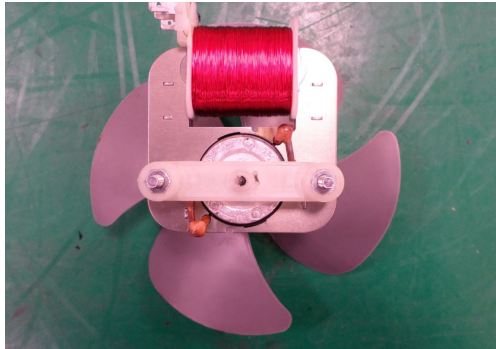
Parts	Explanation Photo	Explanation
Magnetron, Motor Assembly and Lamp		<p>4. Remove screws securing the magnetron to the wave guide.</p>
		<p>5. Take out the magnetron very carefully.</p>
		<p>6. Remove two nuts from the back panel.</p>
		<p>7. Take out the fan motor.</p>

3. Disassembly and Reassembly

3-2 Disassembly of Magnetron, Motor Assembly and Lamp

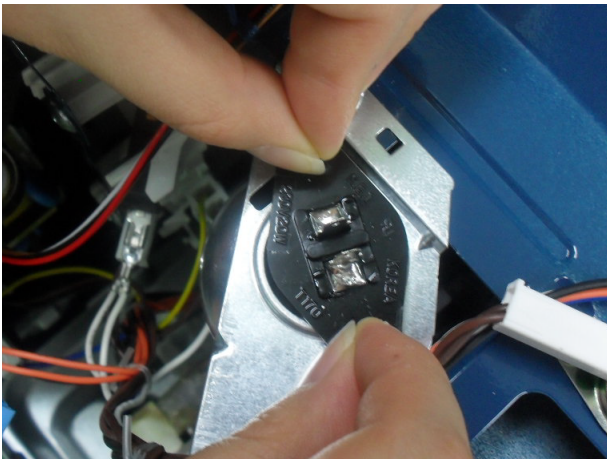
Parts	Explanation Photo	Explanation
Magnetron, Motor Assembly and Lamp		<p>8. Remove the oven lamp from hole of air cover.</p>

NOTE1: When removing the magnetron, make sure that its antenna does not hit any adjacent parts, or it may be damaged.

NOTE2: When replacing the magnetron, be sure to remount the magnetron gasket in the correct position and make sure the gasket is in good condition.

3. Disassembly and Reassembly

3-3 Replacement of High Voltage Transformer

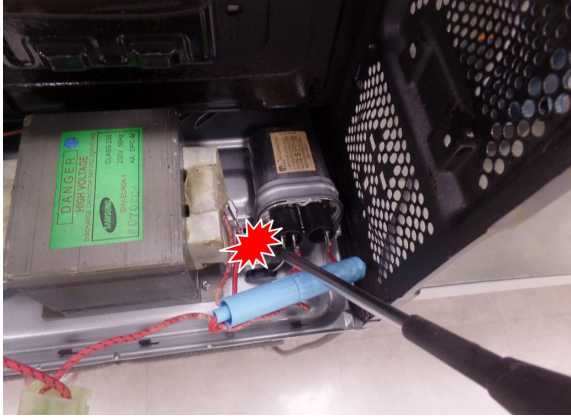
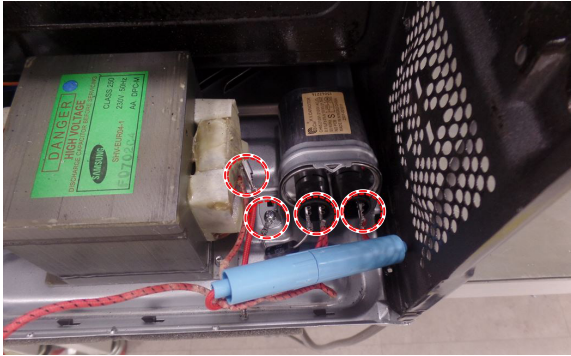
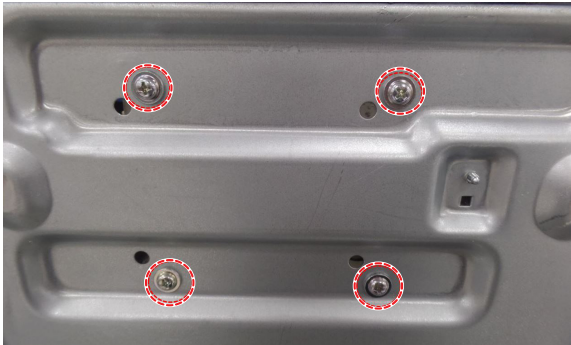
Parts	Explanation Photo	Explanation
<p>High Voltage Transformer</p>		<ol style="list-style-type: none"> 1. Discharge the high voltage capacitor.
		<ol style="list-style-type: none"> 2. Disconnect all the leads.
		<ol style="list-style-type: none"> 3. Remove the mounting bolts.

3. Disassembly and Reassembly

3-3 Replacement of High Voltage Transformer

Parts	Explanation Photo	Explanation
High Voltage Transformer		<ol style="list-style-type: none"> 4. Replace the High Voltage Transformer 5. After replace, reconnect the leads correctly and firmly.



PRECAUTION

Servicemen should remove their watches whenever working close to or replacing the magnetron.



PRECAUTION

There exists HIGH VOLTAGE ELECTRICITY with high current capabilities in the circuits of the HIGHVOLTAGE TRANSFORMER secondary and filament terminals. It is extremely dangerous to work on or near these circuits with the oven energized.

DO NOT measure the voltage in the high voltage circuit including filament voltage of magnetron.

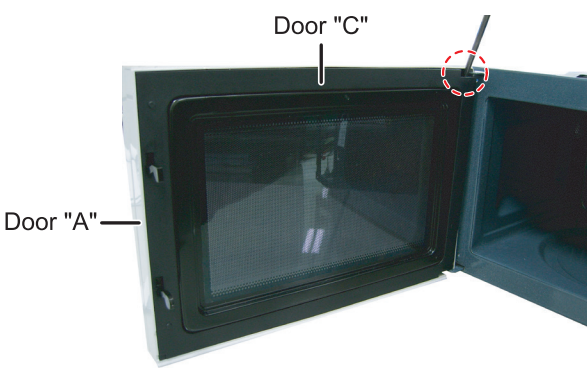
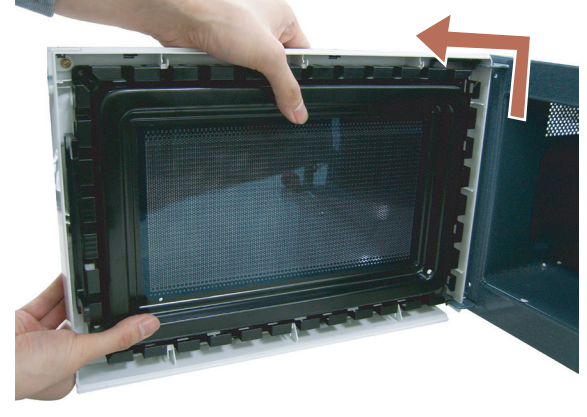
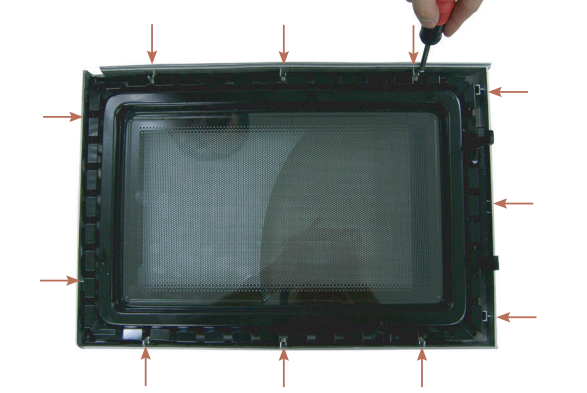
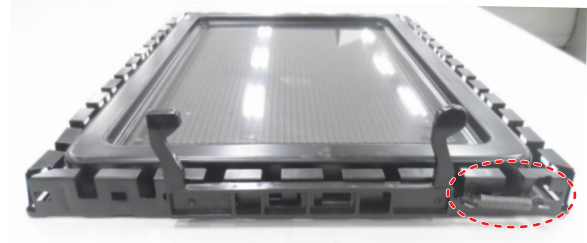

3. Disassembly and Reassembly

3-4 Replacement of Door Assembly

Parts	Disassembly Photo	Explanation
Removal of Door "C"		<p>Insert flat screwdriver into the gap between Door "A" and Door "C" to remove Door "C". Be careful when handling Door "C" because it is fragile. Then remove the door assembly.</p>
Removal of Door Assembly		<p>Lift up the Door Assembly from Cavity.</p>
Removal of Door "E"		<p>Following the procedure as shown in the figure, insert and bend a thin metal plate between Door "E" and Door "A" until you hear the 'tick' sound.</p> <ul style="list-style-type: none"> • Insertion depth of the thin metal plate should be 0.5mm or less.
Removal of Key Door & Spring		<p>Remove the Spring from Door "E" and Key door.</p>

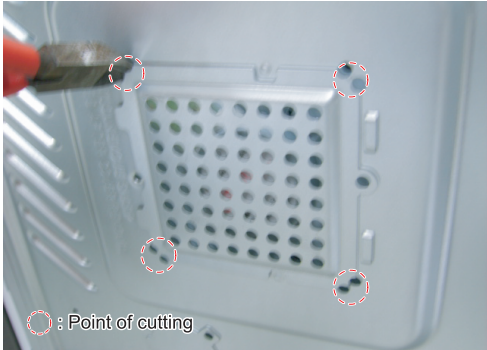
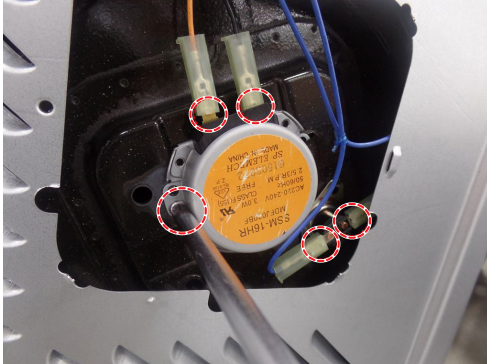

3. Disassembly and Reassembly

3-5 Replacement of Drive Motor

Parts	Explanation Photo	Explanation
Drive Motor		<ol style="list-style-type: none"> 1. Take out the glass tray, guide roller from oven cavity, disconnect power. 2. Remove turn table motor cover from case bottom. <p>CAUTION : Remove sharp edge after cover removal.</p>
		<ol style="list-style-type: none"> 3. Disconnect leads from motor. 4. Remove the screws securing motor to bottom of over cavity.
Drive Motor		<ol style="list-style-type: none"> 5. Lift out the motor. 6. When replacing the motor, be sure to remount it in the correct position. <p>NOTE : The shaft of motor should fit tip coupler.</p>
		<ol style="list-style-type: none"> 7. When reassemble a drive motor cover, give a turn in a 180° and fix with a screw. <p>NOTE : Bring the spare screw from service center.</p>

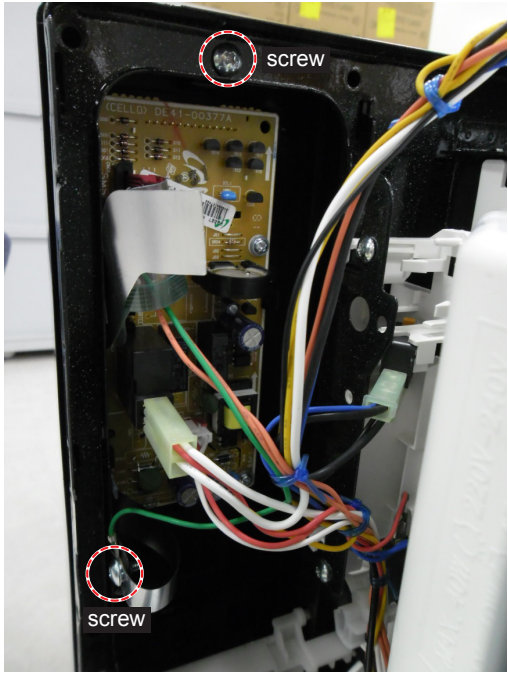

3. Disassembly and Reassembly

3-6 Replacement of Control Circuit Board

Parts	Explanation Photo	Explanation
<p>Removal of Control Box Assembly</p>		<ol style="list-style-type: none"> 1. Be sure to ground any static electric charge in your body and never touch the control circuit. 2. Disconnect the connectors from the control circuit board. 3. Remove screws securing the control box assembly.
<p>Removal of Ass'y P.C.B Assembly</p>		<ol style="list-style-type: none"> 1. Remove screws securing the control circuit board. 2. Lift up the control circuit board from the Ass'y control box.

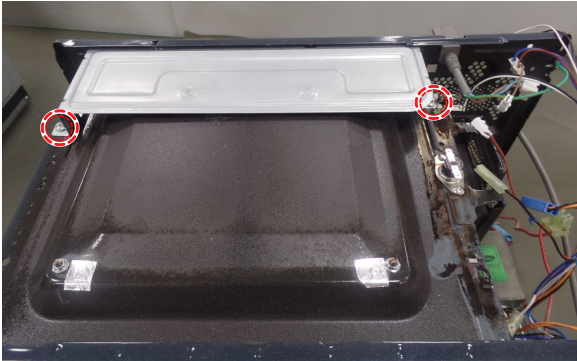
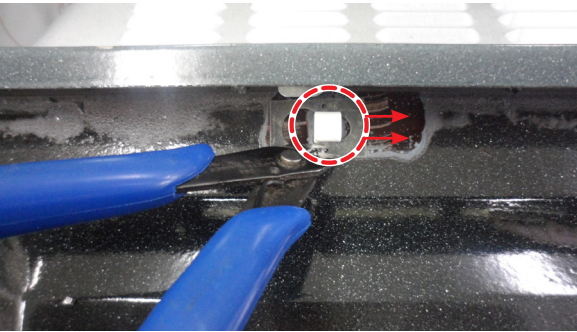

3. Disassembly and Reassembly

3-7 Replacement of Grill heater

Parts	Explanation Photo	Explanation
<p>Braket Upper</p>		<p>1. Remove 2 screw from the Bracket upper.</p>
<p>Spring Plate</p>		<p>2. Press the Center of spring plate and Slice with tools.</p>
<p>Grill Heater</p>		<p>3. Remove fan motor and then remove the Nuts for disassemble the Grill Heater and lead Wire.</p>

4. Troubleshooting

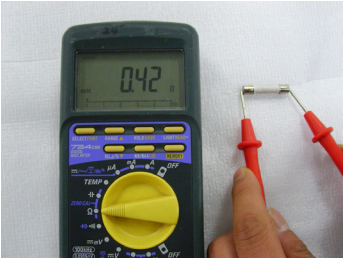
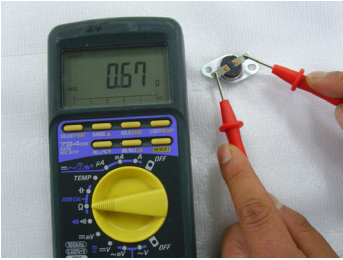
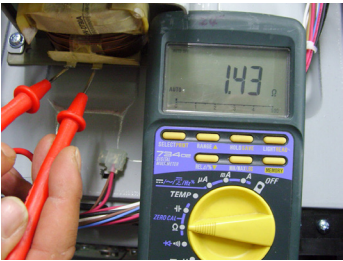
4-1 Parts checking method

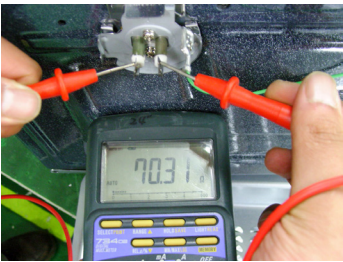
Parts	Photo	Good	No Good
Fuse		0.1 ~ 1 Ω	100 MΩ exceed
T.C.O		0.1 ~ 1 Ω	100 MΩ exceed
H.V Trans		1 ~ 9 Ω	100 MΩ exceed
Fan Motor		10 ~ 99 Ω	100 MΩ exceed
Grill Heater		10 ~ 99 Ω	100 MΩ exceed

4. Troubleshooting

4-2 Information Code Numbering Rule

1. Information CODE NUMBERING RULE is applied to a microwave oven and an oven. (CMO, OTR, Grill, Convection, Commercial etc.)
2. All sensors and devices have their own number.
ex) Gas/Easy/PH Sensor = 1, Temp. Sensor = 2, ...
3. Of each device, No.0~2 refer to Check Option 1~3

C	-	1	0
----------	----------	----------	----------

0 - Others	0 – Check option 1
1 – Gas/Easy/PH Sensor	1 – Check option 2
2 – Temp Sensor	2 – Check option 3
7 – Steam Sensor	.
A – Function	.
d – Door/Key	.
F – Master/Slave Communication	
X – additional Information code	

4. Troubleshooting

4-3 Information Code List

Device	Information Code	Symptom	Solution	Page
Door/Key	C-d0	Key Short Information code (10 seconds) If KEY input is successive more than 10 seconds, marks C-d0 and converts to cancel mode.	Turn off set and restart	22 page

4. Troubleshooting

4-4 Electrical Malfunction

4-4-1 C-d0

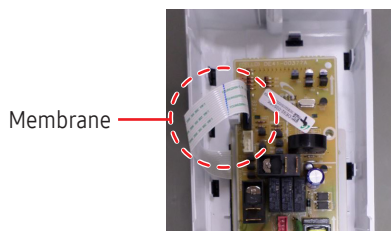
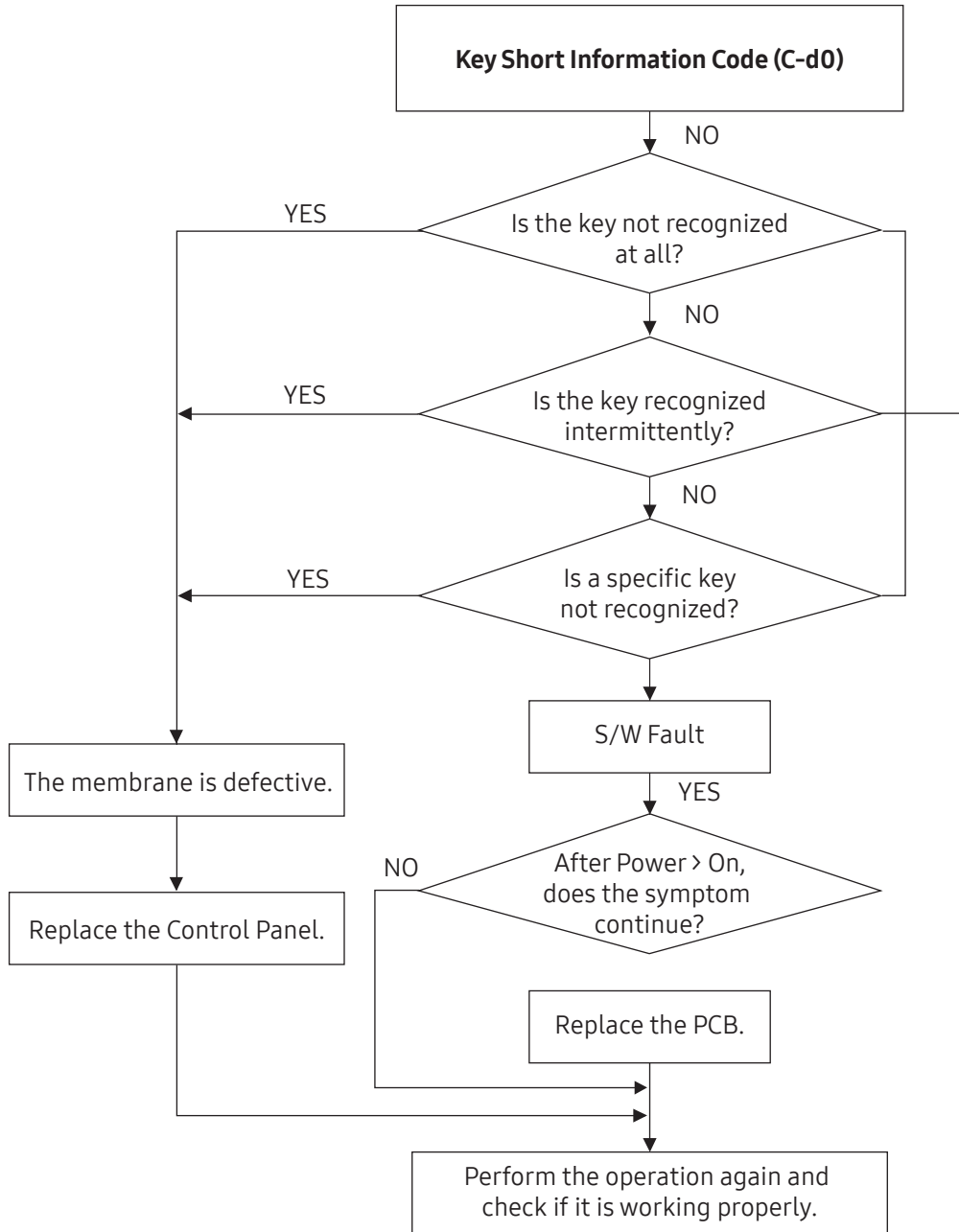

4. Troubleshooting

4-4-2 If button malfunction

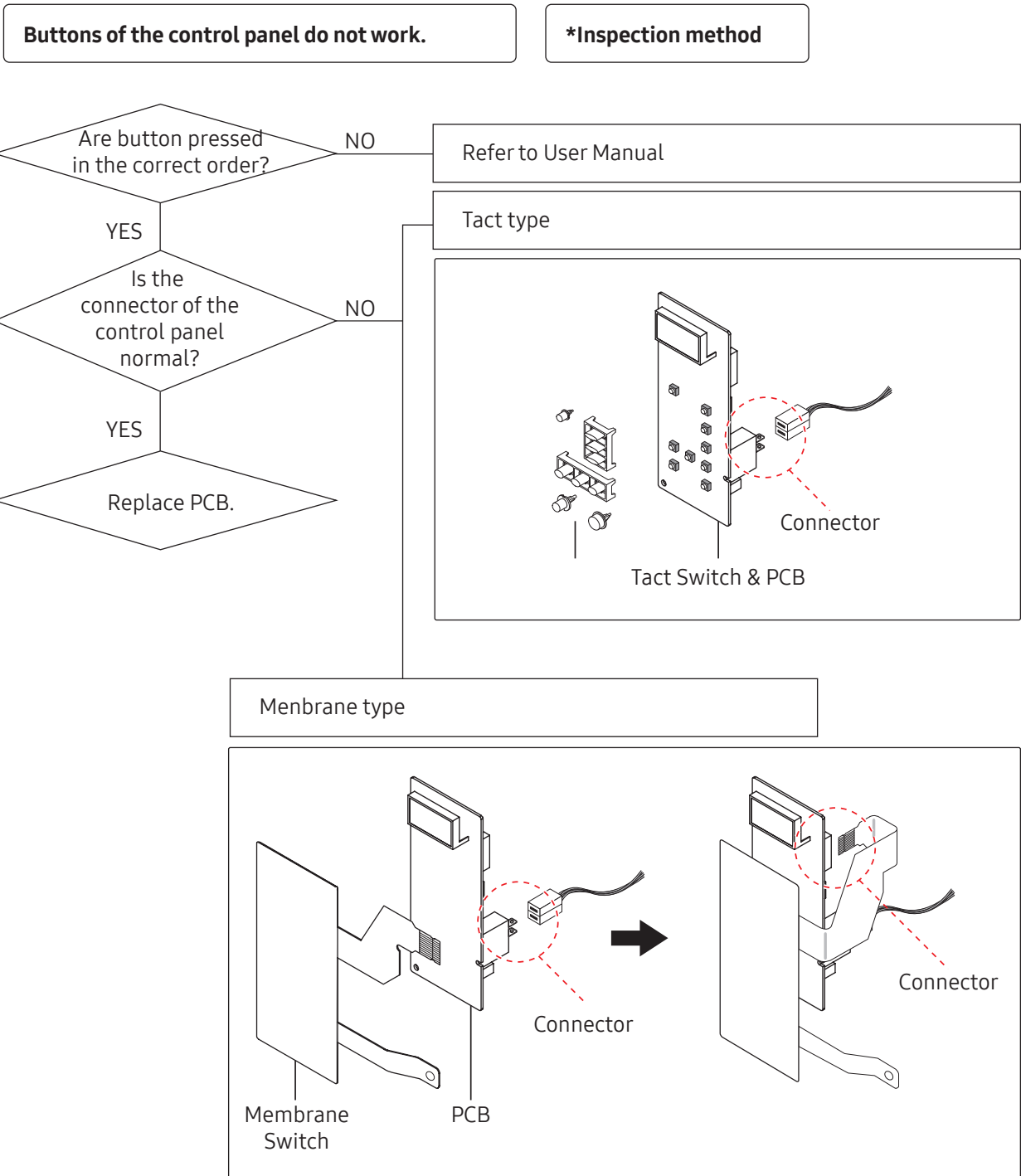

4. Troubleshooting

4-4-3 If food is not heated even though an oven works

Food is not heated even though an oven works.

*Inspection method

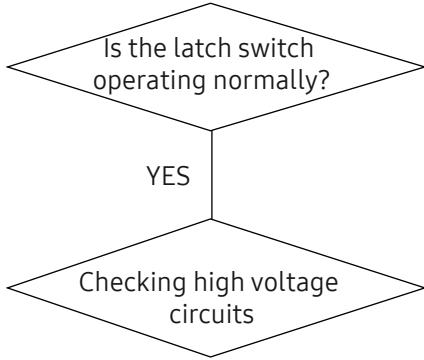

Refer to "Checking high voltage circuits" on the previous page.

NO

Method to control latch switch

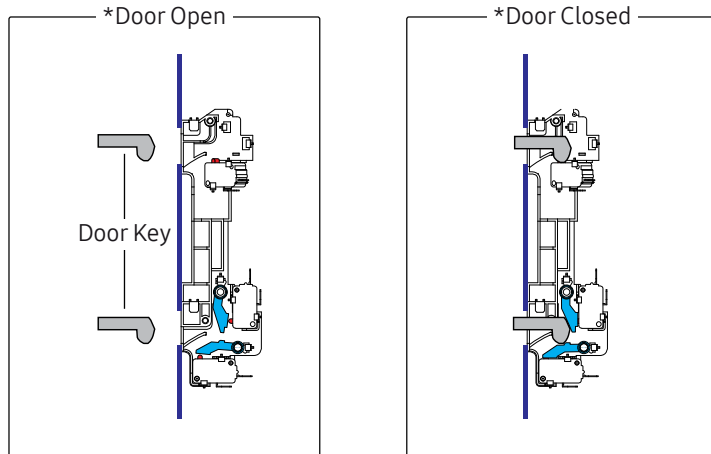

Method to control latch switch

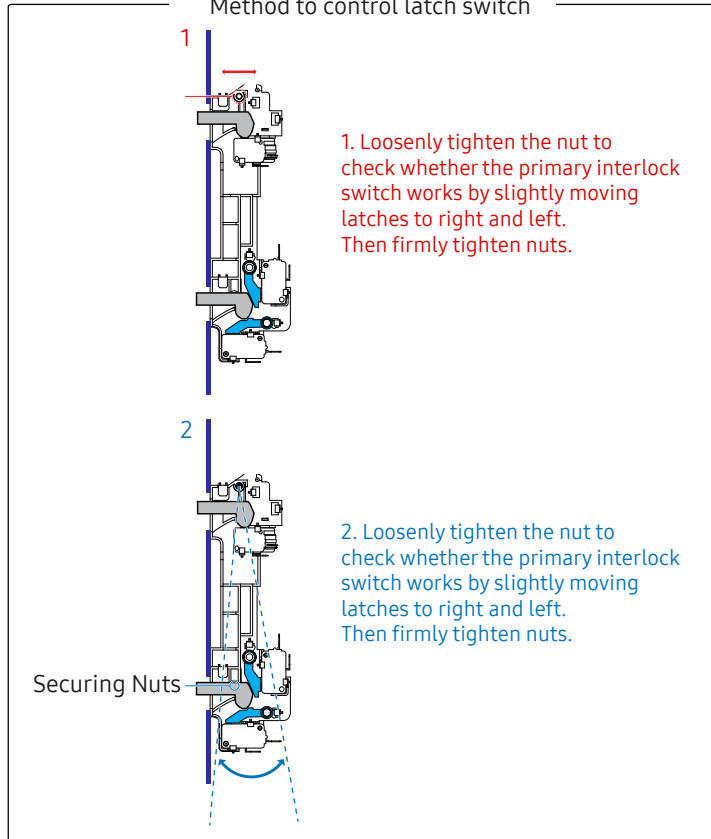

5. PCB Diagrams

5-1 PCB Diagrams

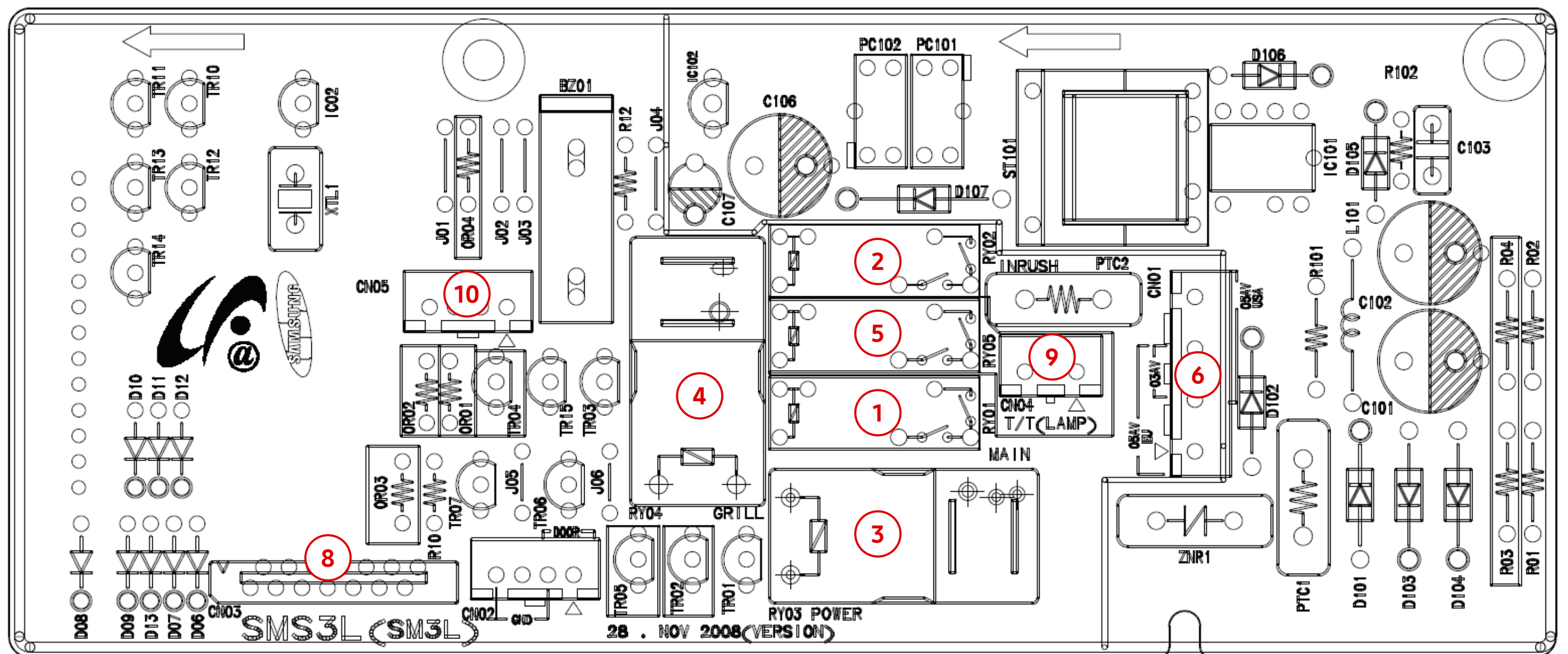

No	Part Number	Part Name	Function and Rule
1	RY01	Main Relay	Fan, Lamp, T/T Control
2	RY02	Inrush Relay	Inrush Electric Current Decrease
3	RY03	Power Relay	MW Power Control
4	RY04	Grill Heater Relay	Grill Heater Control
5	RY05	T/T Relay	Turn Table Motor Control (model option)
6	CN01	Power & Relay Connector	A Terminal for Connecting with Power supply & Relay Contact(Load Control)
7	CN02	Door switch Sensing Connector	A Terminal for Connecting with Door Switch
8	CN03	Membrane switch Connector	A Terminal for Connecting with Membrane Switch
9	CN04	T/T Connector	A Terminal for Connecting with T/T Connector
10	CN05	PH Sensor	A Terminal for Connecting with PH Sensor

5. PCB Diagrams

5-1 PCB Diagrams

RY08

- 1) GRILL HEATER RELAY CONTACT1
- 2) GRILL HEATER RELAY CONTACT2

RY03

- 1) POWER RELAY CONTACT (HVT POWER1)
AC POWER NEUTAL (AC220V~240V)
- 2) POWER RELAY CONTACT2 (HVT POWER2)

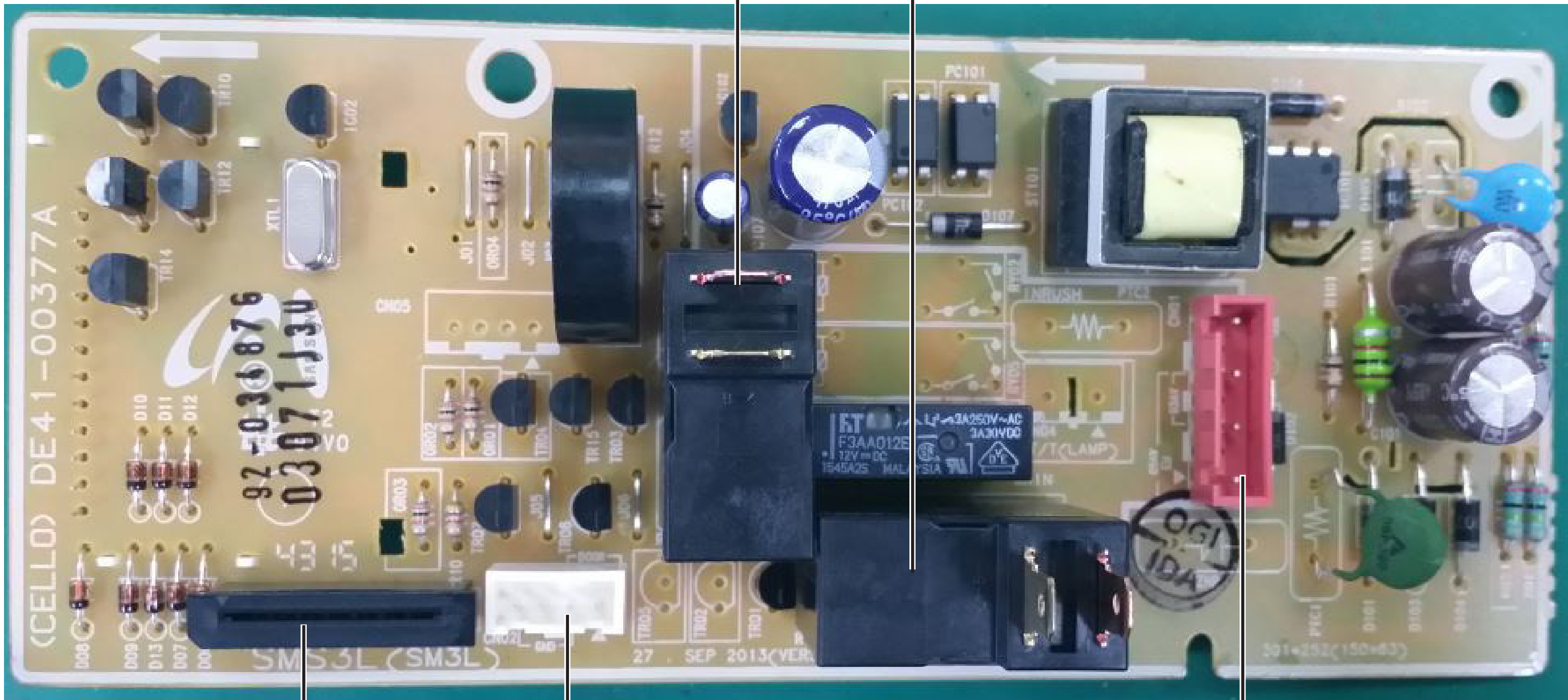

CN03

- 1) KEY OUTPUT1
- 2) KEY OUTPUT2
- 3) KEY OUTPUT3
- 4) KEY OUTPUT4
- 5) KEY OUTPUT5
- 6) KEY OUTPUT6
- 7) KEY OUTPUT7
- 8) KEY OUTPUT8
- 9) KEY INPUT1
- 10) KEY INPUT2
- 11) KEY INPUT3
- 12) KEY INPUT4
- 13) KEY INPUT5
- 14) ENCODER COMMON
(ENCODER S/W MODEL)

CN02

- 1) DOOR SWITCH (12V)
- 2) GND
- 3) DOOR SWITCH (RY_12V)
- 4) GND

CN02

- 1) MONTOR S/W
- 2) NO PIN
- 3) AC POWER LIVE (AC220V~240V)
- 4) NO PIN
- 5) MAIN RELAY
(Connect with Lamp, T/Table)
- 6) NO PIN
- 7) NRUSH CIRCUIT

6. Wiring Diagrams

6-1 Wiring Diagrams

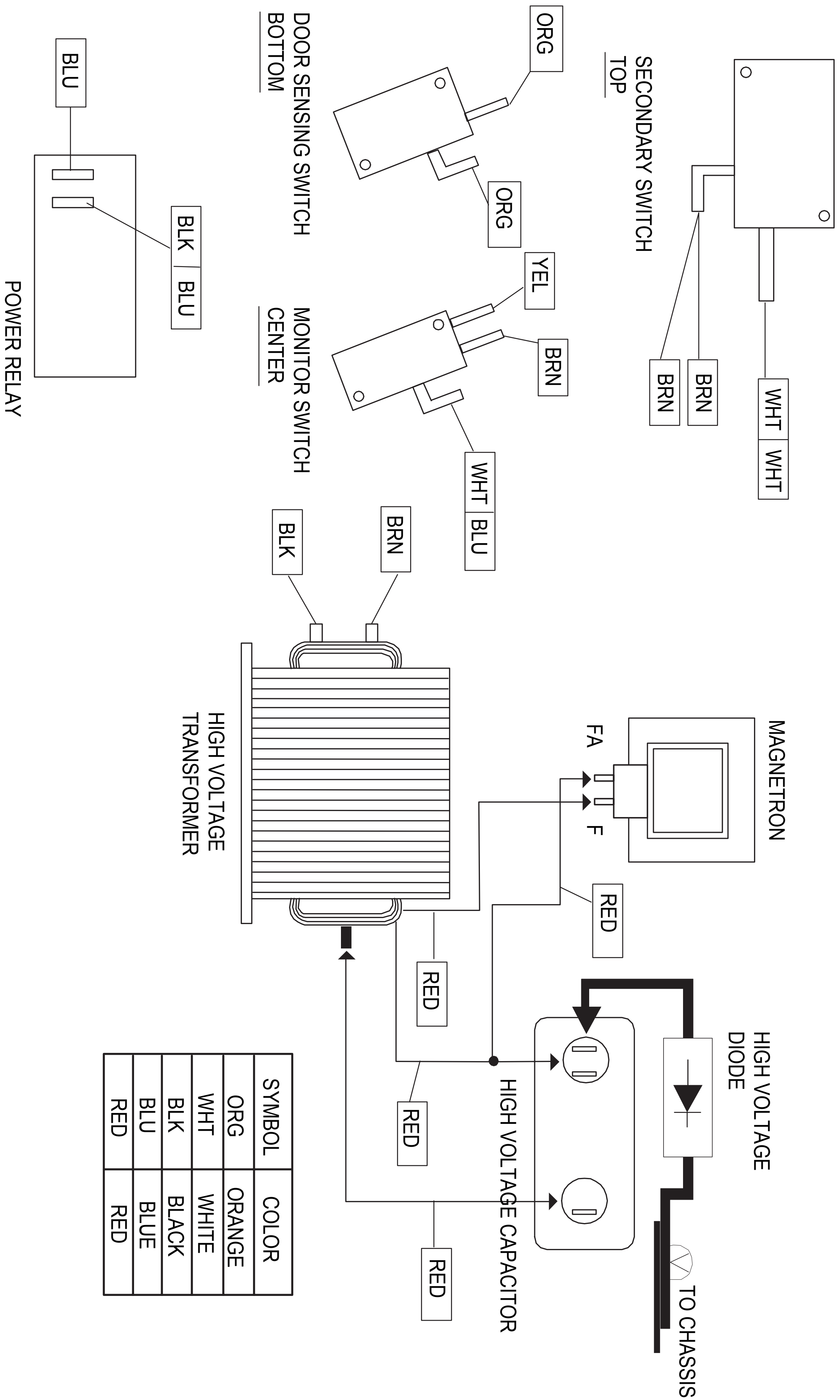

6. Wiring Diagrams

6-1 Wiring Diagrams

SCHEMATIC DIAGRAM

MODEL : 0.8 Sheath GRILL with Electric

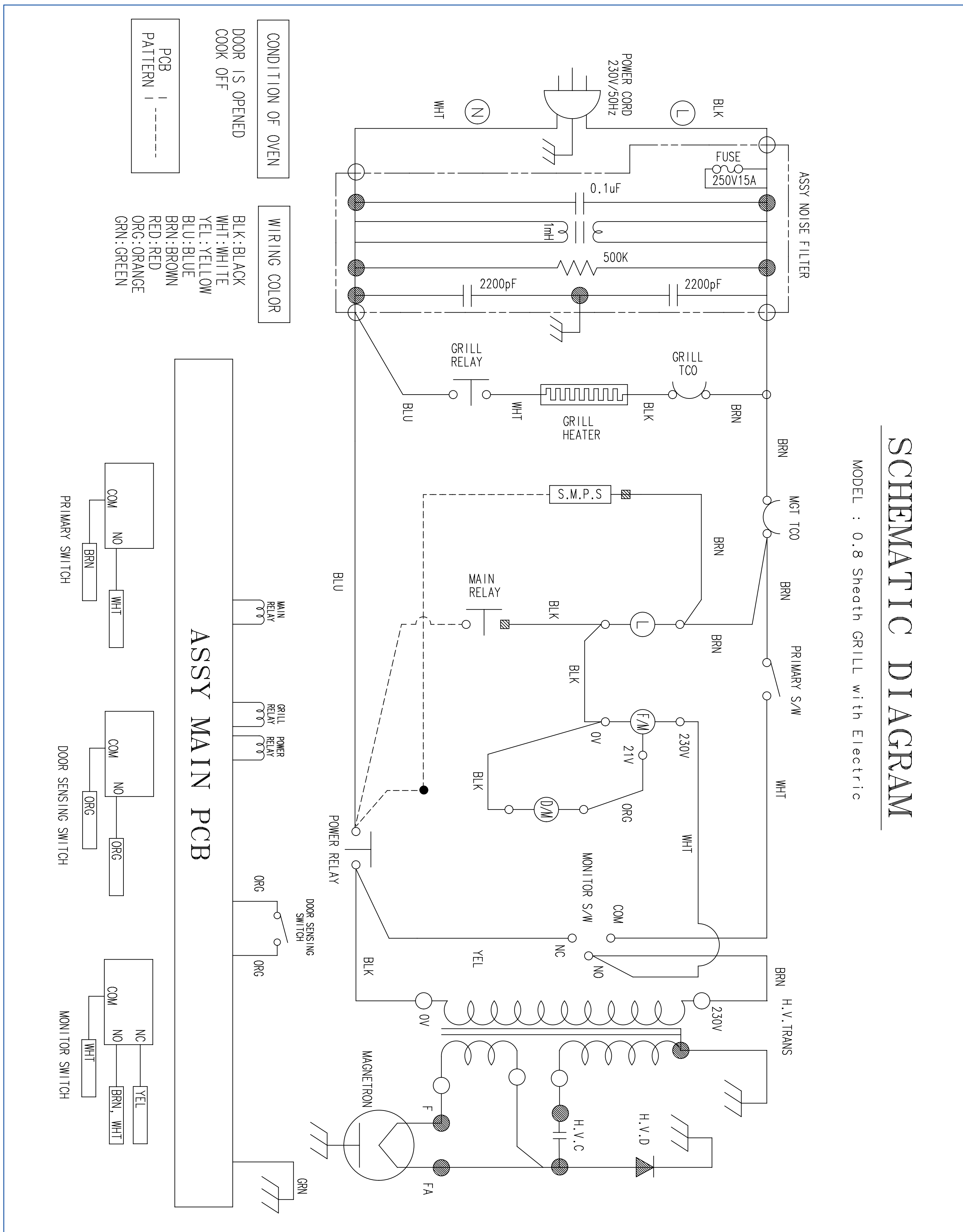

7. Schematic Diagrams

7-1 Schematic Diagrams

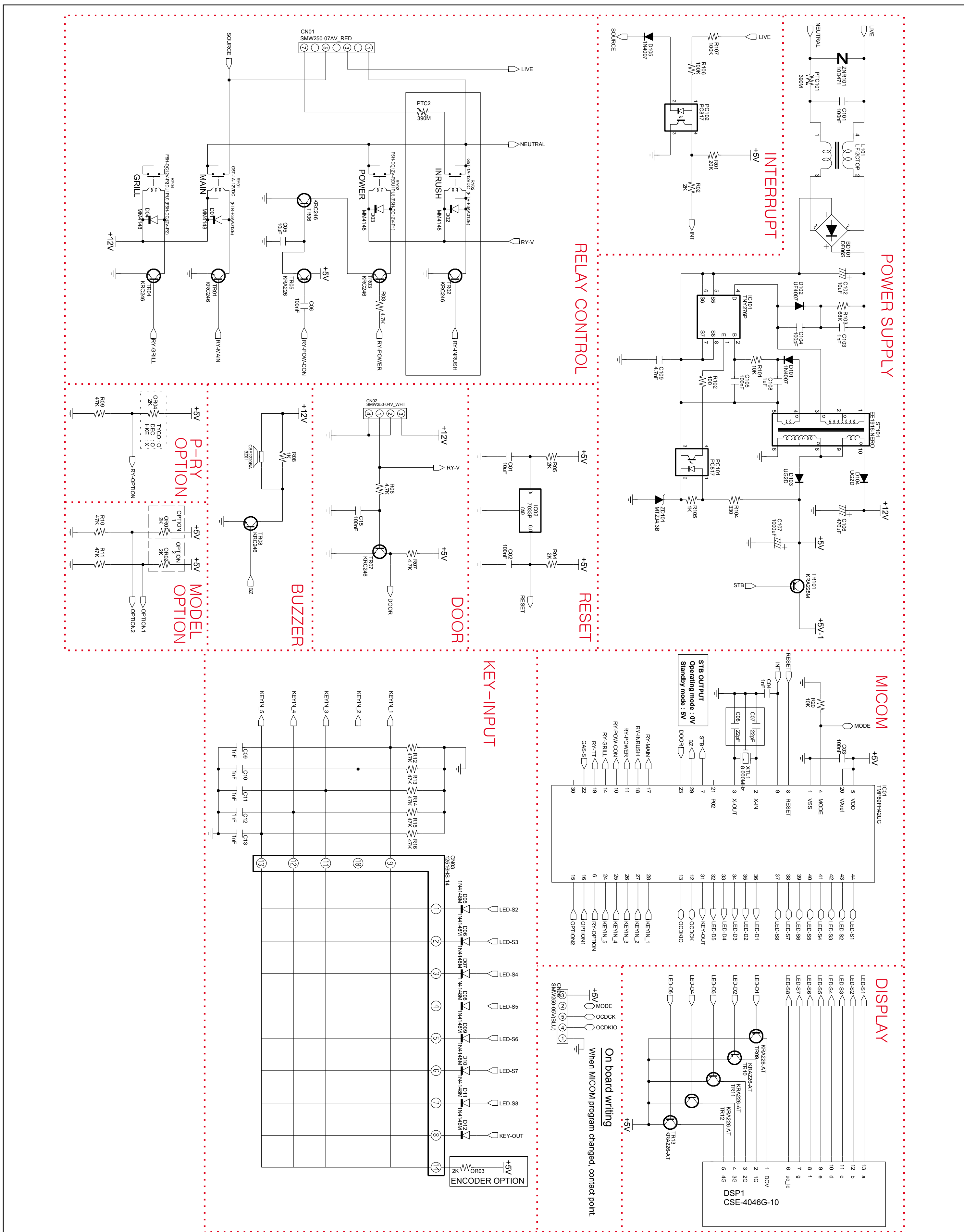

SAMSUNG

GSPN (GLOBAL SERVICE PARTNER NETWORK)

Area	Web Site
Europe, CIS, Mideast & Africa	gspn1.samsungcsportal.com
Asia	gspn2.samsungcsportal.com
North & Latin America	gspn3.samsungcsportal.com
China	china.samsungportal.com

**This Service Manual is a property of Samsung Electronics Co.,Ltd.
Any unauthorized use of Manual can be punished under applicable
International and/or domestic law.**

© Samsung Electronics Co., Ltd.
2018 Printed in Korea