



**MARQUE: MOULINEX**

**REFERENCE: FP545510**

**CODIC: 4569920**



**NOTICE**



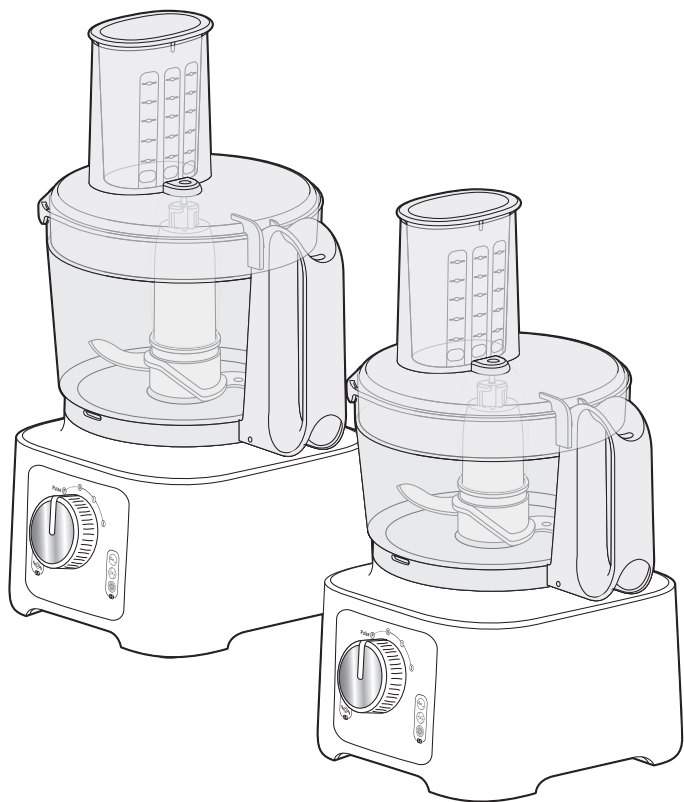

FR

EN

DE

NL

ES

PT

IT

EL

RU

UK

KK

AR

FA

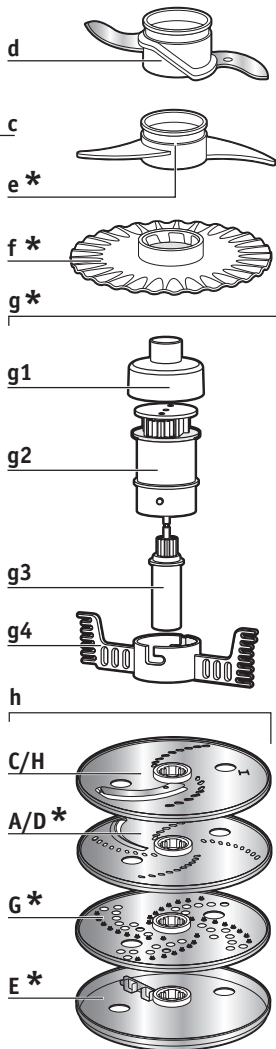
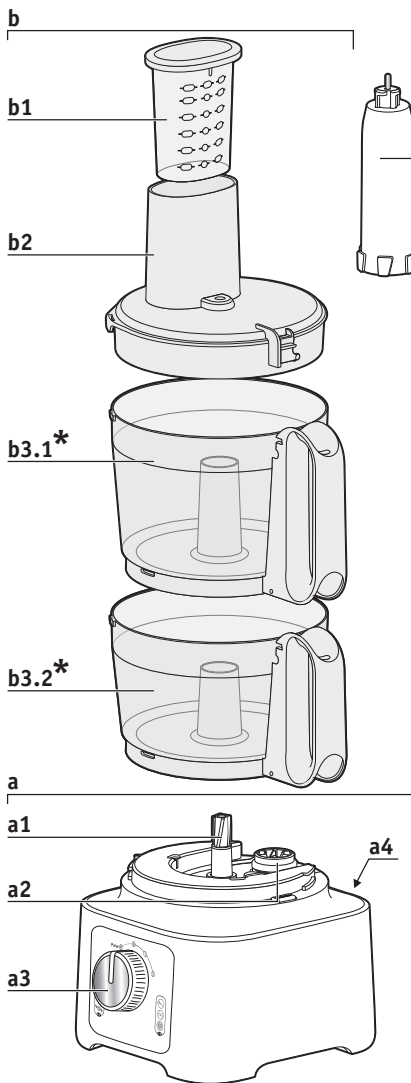

i \*

i1-1 \*

i2-1 \*

i1-2 \*

i2-2 \*

i3

m \*

m1

m2

m7-1 m7-2

m8 m7 m6 m5

m4

m3

i4 \*

i5 \*

j \*

j1

j2

j3

k \*

k1

k2

l \*

n \*

o

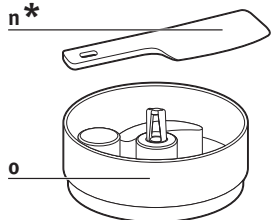
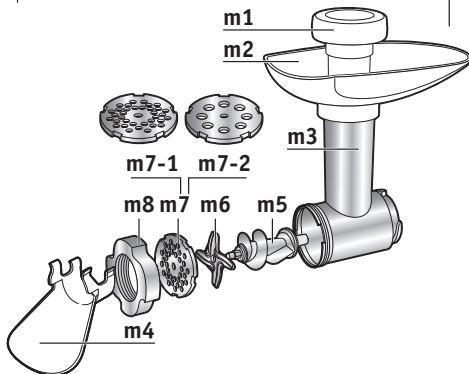
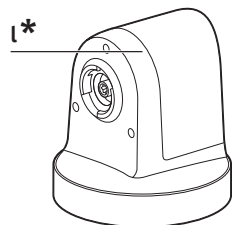
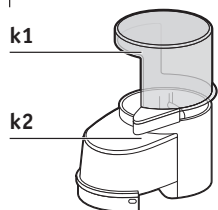
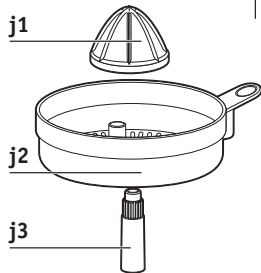
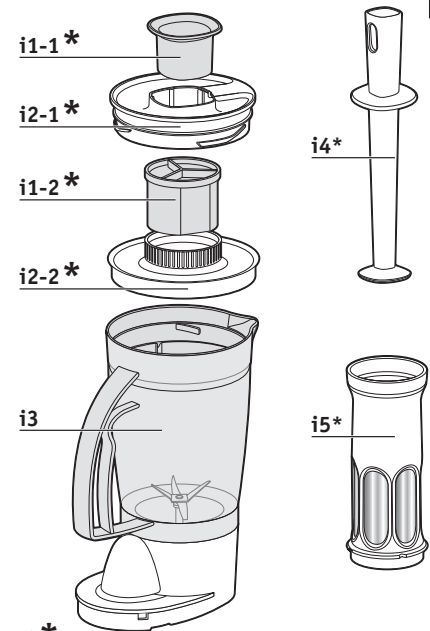

b,c,d,e,f,  
g,h,i,j,k,  
m,n,o

1.1

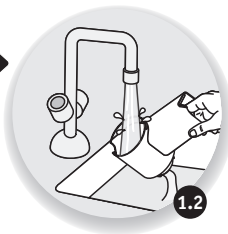

1.2

Pulse

Pulse (P)

2.1

1 2

2.2

stop

0

2.3

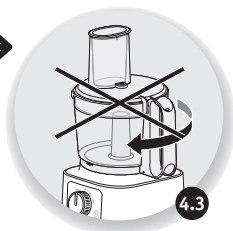
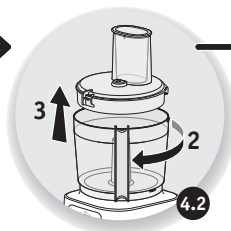
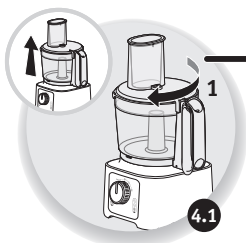
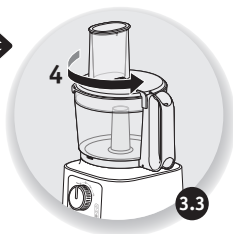
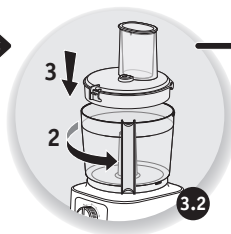
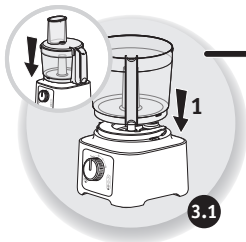

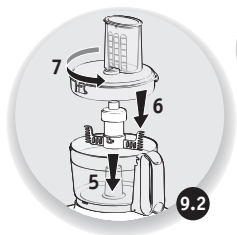
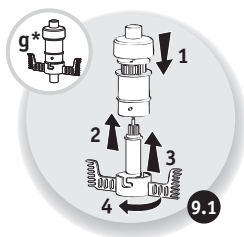
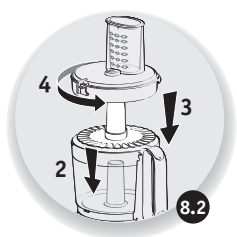
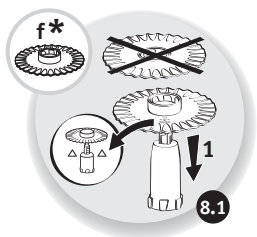
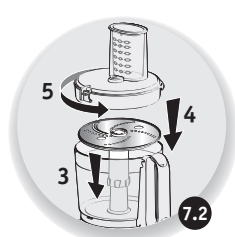
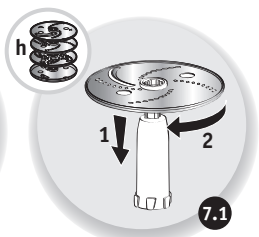
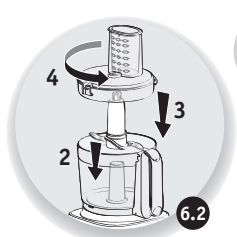
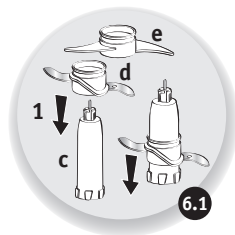
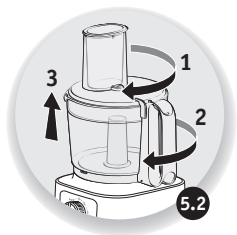
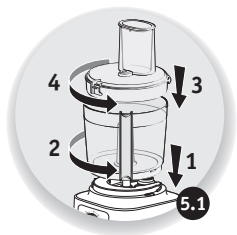

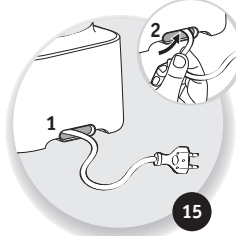
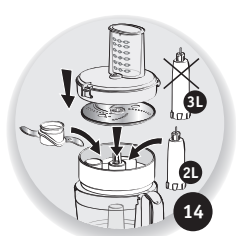
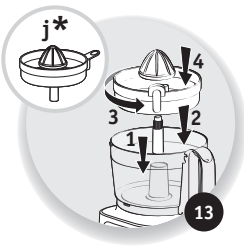
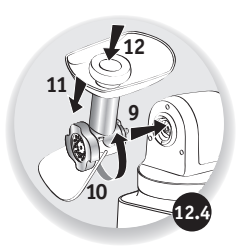
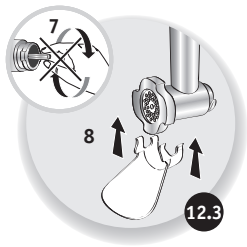
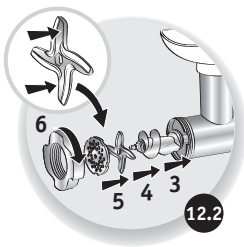
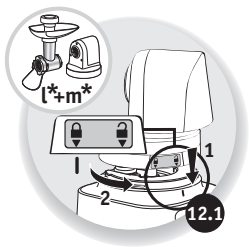
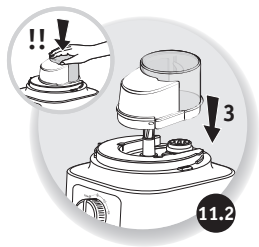
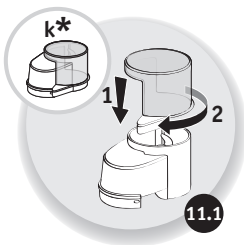
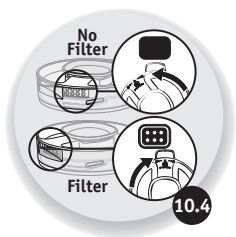





































2,2L



















3L



						
		300g max	30s	600g max	1 min	② + Pulse
						
		0,5L	20s	1L	45s	
   		600g	30s	1Kg	60s	
		500g	30s	800g	60s	
		800g	1min 30 ▶ 2min	1,2Kg	1min 30 ▶ 3min	
		0,8L	1min ▶ 1min 30	1,4L	1min ▶ 1min 30	
 		 1max	 30 s ▶ 3min	 1max	 30 s ▶ 3min	① ②
		0,2L max	 30 s ▶ 3min	0,2L max	 30 s ▶ 3min	
		6max	 30 s ▶ 3min	6max	 30 s ▶ 3min	
   		300g	30s	600g	1min	②
						①
						②
						①





				
 <b>i*</b>		0,8L max	2min	<b>① ②</b> + <b>Pulse</b>
				
		1L max		
<b>+</b>		0,8L max	2min	
 <b>j*</b>		0,6L max	1min	<b>①</b>
 <b>k*</b>		50g max	10s	<b>②</b> + <b>Pulse</b>
		80g max	5s	
 <b>l* m*</b>	<b>①</b> ↓ 		15min	<b>① ②</b>
<b>②</b> ↓  2x2cm				
				

Les accessoires, contenus dans le modèle que vous venez d'acheter, sont représentés sur l'étiquette située sur le dessus de l'emballage.

\*selon modèle

**AVERTISSEMENT** : Les consignes de sécurité font partie de l'appareil. Veuillez les lire attentivement avant d'utiliser votre nouvel appareil. Gardez-les dans un endroit où vous pourrez les retrouver et vous y référer ultérieurement. FR

- N'utilisez jamais le pilon (i4\*) sans le couvercle du bol mixeur (i2-1\*) sinon il risque de toucher les lames.

## CONSEILS D'UTILISATION

- Presse-agrumes (j\*) : attention, vous devez rincer le panier filtre (j2\*) tous les 0,2 L.
- Tête hachoir (m\*) : assurez-vous que la viande soit bien décongelée.

## NETTOYAGE

- Débranchez l'appareil.
- Pour un nettoyage plus facile, rincez rapidement les accessoires après leur utilisation.
- Lavez et essuyez les accessoires : ils passent au lave-vaisselle, dans l'eau ou sous le robinet à l'exception de l'ensemble de la tête hachoir (l+m3+m6+m7+m8) et du bloc moteur (a). Essuyez ces derniers avec une éponge humide.
- Une fois essuyés, recouvrez d'huile alimentaire le couteau 4 branches (m6) et les grilles (m7) pour éviter tout risque d'oxydation.
- Versez de l'eau chaude additionnée de quelques gouttes de savon liquide dans le bol mixer (i3). Fermez le couvercle (i2), muni du bouchon doseur (i1). Donnez quelques impulsions. Débranchez l'appareil. Rincez le bol.
- **Les lames des accessoires sont très affûtées. Manipulez-les avec précaution.**

**Astuce** : En cas de coloration de vos accessoires par des aliments (carottes, oranges...), frottez-les avec un chiffon imbibé d'huile alimentaire, puis procédez au nettoyage habituel.

## SI VOTRE APPAREIL NE FONCTIONNE PAS QUE FAIRE ?

Si votre appareil ne fonctionne pas, vérifiez :

- le branchement de votre appareil.
- le verrouillage de chaque accessoire.

Votre appareil ne fonctionne toujours pas ? Adressez-vous à un centre service agréé (voir liste dans le livret Service).

## ACCESSOIRES

Vous pouvez personnaliser votre appareil et vous procurer auprès de votre revendeur habituel ou d'un centre service agréé, les accessoires suivants :

- **d** : Couteau hachoir inox
- **e** : Couteau pétrin
- **f** : Disque émulsionneur
- **g** : batteur
- **h** : Disques coupe - légumes
  - C/H : Râpé gros / Tranché gros
  - A/D : Râpé fin / Tranché fin
  - G : Parmesan - Reibekuchen
  - E : Coupe-frites
- **i** : Bol mixer
- **i5, i4, i1-1 et i2-1** : Filtre à jus + pilon + couvercle + doseur
- **j** : presse-agrume
- **k** : Moulin fines-herbes
- **l + m** : Adaptateur + hachoir
- **n** : spatule

**Attention, aucun accessoire ne pourra vous être vendu sans présentation de votre notice d'utilisation ou de votre appareil.**