

TEFAL

FRITEUSE

FF232815

PRINCIPIO 2 EN 1

MANUEL D'UTILISATION



Besoin d'aide ?

Rendez-vous sur votre communauté <https://sav.darty.com>



principio

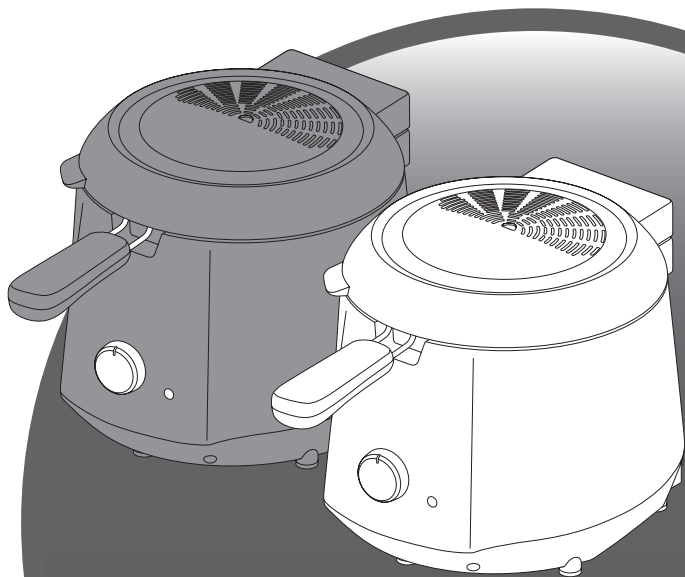

www.groupeseb.com

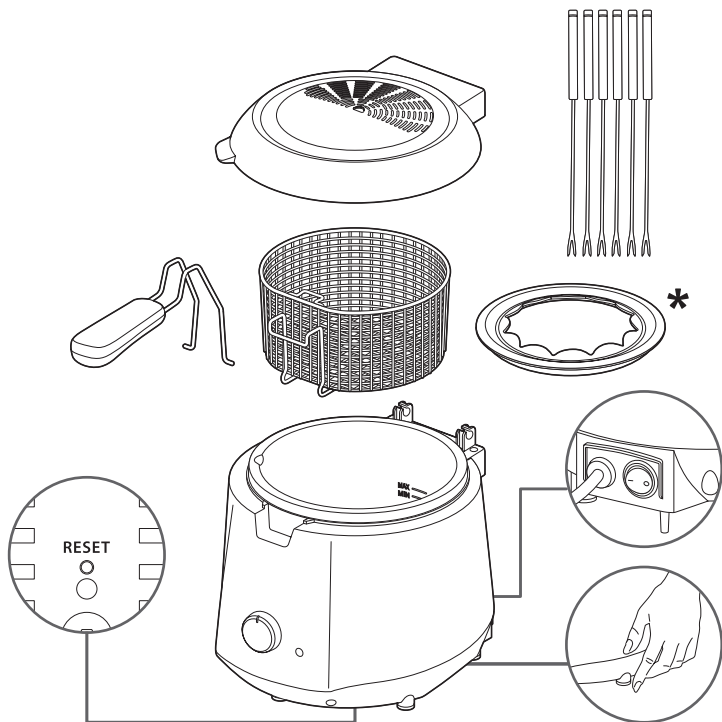

* selon modèle • depending on the model • je nach Modell • a seconda modello • según el modelo •
 consoante os modelos • Ανάλογα με το μοντέλο • В зависимости от модели • залежно від моделі •
 Zależnie od modelu • az egyes modellek szerint • podle modelu • podľa modelu • В зависимости от модели •
 In funcție de model • зависно од модела • zavisno od modela • Oleda na model • بستہ یہ مدل

1



2

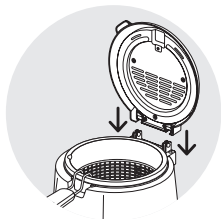
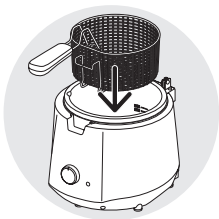
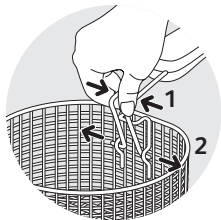
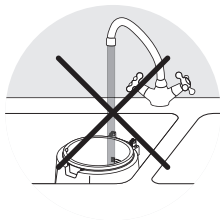
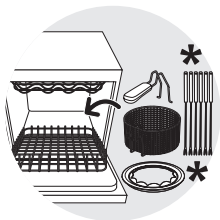
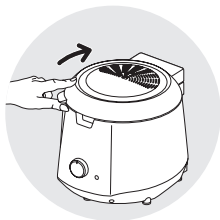
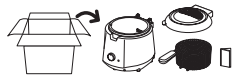



3



Min 1 L
Max 1.2 L

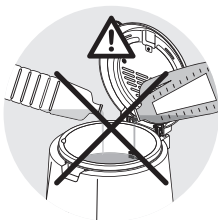
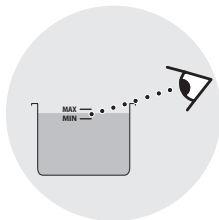
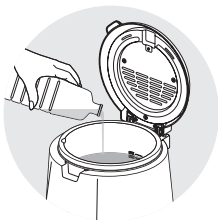

4



Max 600 g



400 g

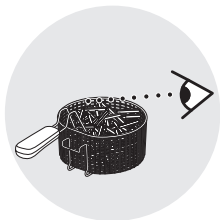

Max 500 g





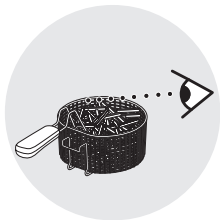
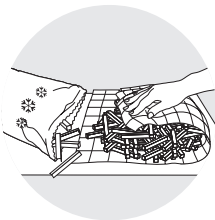

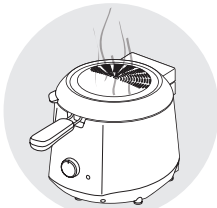
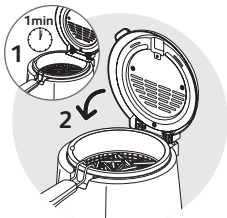
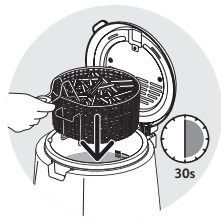
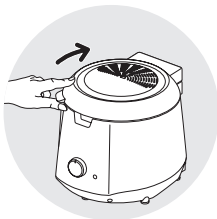
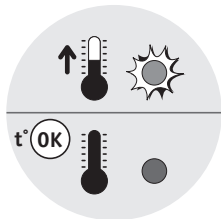
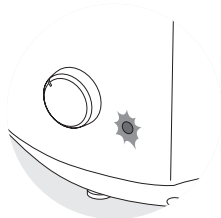
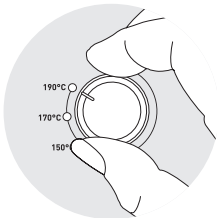
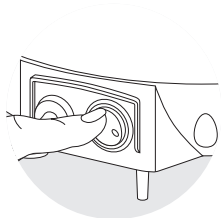
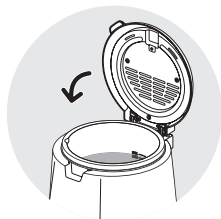













250 g







	Nb		 °C	
		600 g	190°C	13-16 min
		400 g	190°C	11-13 min
		50 g	170 °C	2-4 min
	Nb		 °C	
		500 g	190°C	11-13 min
		250 g	190°C	7-9 min
		500 g	190°C	4-6 min
		500 g	170°C	4-6 min

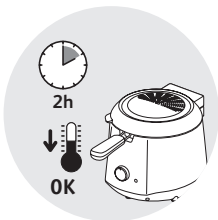
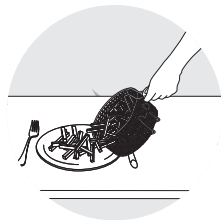
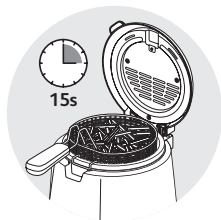
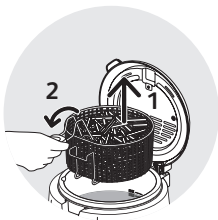
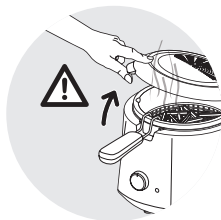
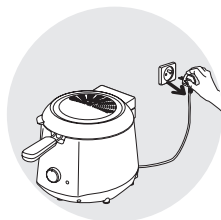
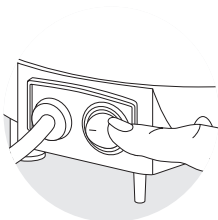
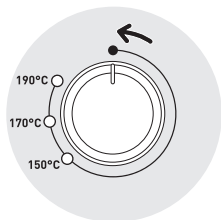

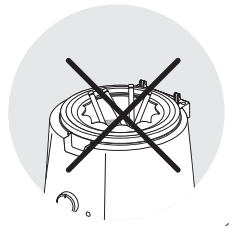
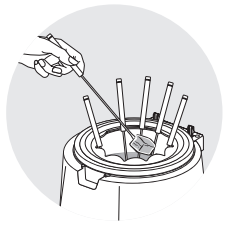
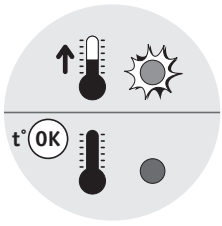
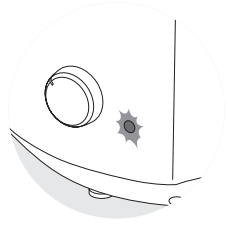
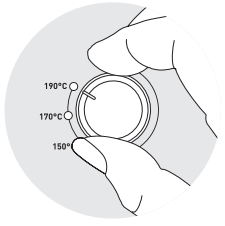
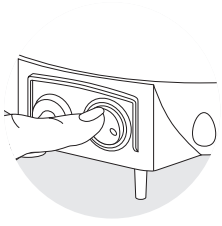
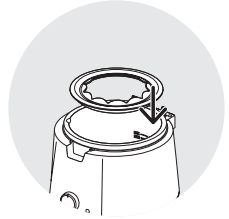
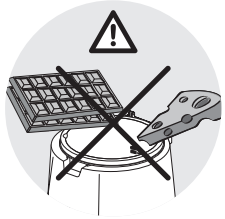
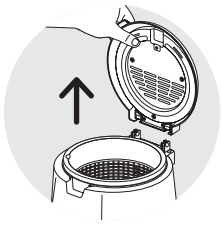
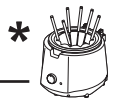

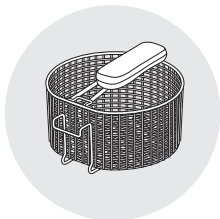
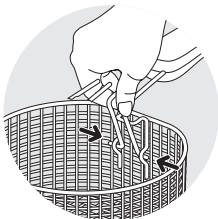
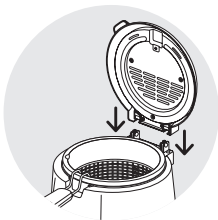
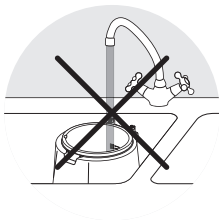
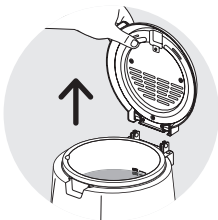
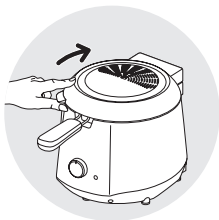

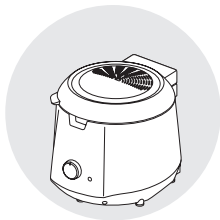

10

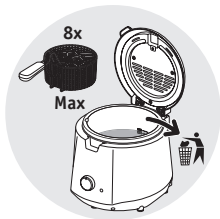

11

11

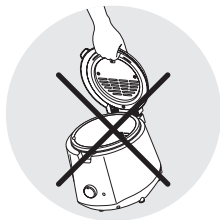

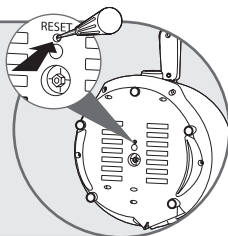
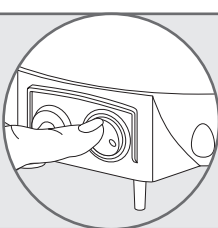
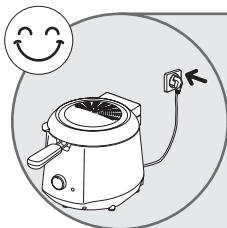
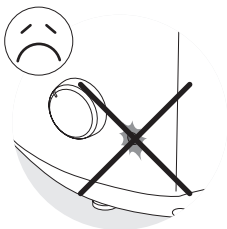

12



12

INTERNATIONAL GUARANTEE COUNTRY LIST

SMALL HOUSEHOLD APPLIANCES

			
ARGENTINA	0800-122-2732	2 años 2 years	GRUPE SEB ARGENTINA S.A. Billinghurst 1833 3° C1425DTK Capital Federal Buenos Aires
ՀԱՅԱՍՏԱՆ ARMENIA	010 55-76-07	2 տարի 2 years	ՓԲԸ <<ԳՐՈՒՊՊԱ ՄԵԲ>> 125171, ՄՈՍԿՎԱ, ԼԵՆԻՆԳՐԱԴՅԱՆ ԽճՈՒՂԻ, 16A, ԵՒՆ.3
AUSTRALIA	1300307824	1 year	GRUPE SEB AUSTRALIA PO Box 7535, Silverwater NSW 2128
ÖSTERREICH AUSTRIA	01 890 3476	2 Jahre 2 years	GRUPE SEB DEUTSCHLAND GmbH Theodor-Stern-Kai 1 60486 Frankfurt am Main
البحرين BAHRAIN	17716666	1 year	www.tefal-me.com
БЕЛАРУСЬ BELARUS	017 2239290	2 года 2 years	ЗАО «Группа СЕБ-Восток», 125171, Москва, Ленинградское шоссе, д. 16А, стр. 3
BELGIQUE BELGIE BELGIUM	070 23 31 59	2 ans 2 jaar 2 years	GRUPE SEB BELGIUM SA NV 25 avenue de l'Espérance - ZI 6220 Fleurus
BOSNA I HERCEGOVINA	Info-linija za potrošače 033 551 220	2 godine 2 years	SEB Developpement Predstavništvo u BiH Vrazova 8/II 71000 Sarajevo
BRASIL BRAZIL	11 2915-4400	1 ano 1 year	SEB COMERCIAL DE PRODUTOS DOMÉSTICOS LTDA Rua Venâncio Aires, 433, Pompéia, São Paulo/SP
БЪЛГАРИЯ BULGARIA	0700 10 330	2 години 2 years	ГРУП СЕБ БЪЛГАРИЯ ЕООД бул. България 81 В, ет. 5 1404 София
CANADA	1-800-418-3325	1 an 1 year	GRUPE SEB CANADA 345 Passmore Avenue Toronto, ON M1V 3N8
CHILE	02 2 884 46 06	2 años 2 years	GRUPE SEB CHILE Comercial Ltda Av. Providencia, 2331, piso 5, oficina 501 Santiago
COLOMBIA	018000520022	2 años 2 years	GRUPE SEB COLOMBIA Apartado Aereo 172, Kilometro 1 Via Zipaquira Cajica Cundinamarca
HRVATSKA CROATIA	01 30 15 294	2 godine 2 years	SEB mku & p d.o.o. Sarajevska 29, 10000 Zagreb
ČESKÁ REPUBLIKA CZECH REPUBLIC	731 010 111	2 roky 2 years	Groupe SEB ČR s.r.o. Futurama Business Park (budova A) Sokolovská 651/136a 186 00 Praha 8

DANMARK DENMARK	44 66 31 55	2 år 2 years	GRUPE SEB NORDIC AS Tempovej 27 2750 Ballerup
مصر EGYPT	16622	سنة واحدة 1year	جروب سب ايجيبت القاهرة: ١٢١ شارع الحجاز، مصر الجديدة الإسكندرية: طريق ٤ مايو، سموحة
EESTI ESTONIA	668 1286	2 aastat 2 years	Groupe SEB Polska Sp. z o.o. Gdański Business Center II D ul. Inflancka 4C 00-189 Warsaw
SUOMI FINLAND	09 622 94 20	2 vuotta 2 years	Groupe SEB Finland Äyritie 12C 01510 Vanta
FRANCE Continentale + Guadeloupe, Martinique, Réunion, St- Martin	09 74 50 47 74	2 ans 2 years	GRUPE SEB France Service Consommateur Tefal 112 Ch. Moulin Carron, TSA 92002 69134 ECULLY Cedex
DEUTSCHLAND GERMANY	0212 387 400	2 Jahre 2 years	GRUPE SEB DEUTSCHLAND GmbH Theodor-Stern-Kai 1 60486 Frankfurt am Main
ELLADA GREECE	2106371251	2 χρόνια 2 years	SEB GROUPE ΕΜΜΑΔΟΣ Α.Ε. Καβαλιεράτου 7 T.K. 145 64 Κ. Κηφισιά
香港 HONG KONG	8130 8998	1 year	SEB ASIA Ltd. Room 903, 9/F, South Block, Skyway House 3 Sham Mong Road, Tai Kok Tsui, Kowloon Hong-Kong
MAGYARORSZÁG HUNGARY	06 1 801 8434	2 év 2 years	GRUPE SEB CENTRAL-EUROPE Kft. 2040 Budaörs, Puskás Tivadar út 14
INDONESIA	+62 21 5793 7007	1 year	GRUPE SEB INDONESIA (Representative office) Sudirman Plaza, Plaza Marein 8th Floor JL Jendral Sudirman Kav 76-78, Jakarta 12910, Indonesia
ITALIA ITALY	1 99 207 354	2 anni 2 years	GRUPE SEB ITALIA S.p.A. Via Montefeltro, 4 20156 Milano
日本 JAPAN	0570-077772	1 year	株式会社グループセブジャパン 〒144-0042 東京都大田区羽田旭町11-1 羽田クロノゲート事務棟5F
الأردن JORDAN	5665505	1 year	www.tefal-me.com
ҚАЗАҚСТАН KAZAKHSTAN	727 378 39 39	2 жыл 2 years	ЖАҚ «Группа СЕБ- Восток» 125171, Мәскеу, Ленинградское шоссесі, 16А, 3 үйі
한국어 KOREA	1588-1588	1 year	(유)그룹 세브 코리아 서울시 종로구 청계천로 35 관정빌딩 2층 03188

الكويت KUWAIT	1807777 Ext :2104	1 year	www.tefal-me.com
LATVJA LATVIA	6 616 3403	2 gadi 2 years	Groupe SEB Polska Sp. z o.o. Gdański Business Center II D ul. Inflancka 4C 00-189 Warsaw
لبنان LEBANON	4414727	1 year	www.tefal-me.com
LIETUVA LITHUANIA	5 214 0057	2 metai 2 years	Groupe SEB Polska Sp. z o.o. Gdański Business Center II D ul. Inflancka 4C 00-189 Warsaw
LUXEMBOURG	0032 70 23 31 59	2 ans 2 years	GRUPE SEB BELGIUM SA NV 25 avenue de l'Espérance - ZI 6220 Fleurus
МАКЕДОНИЈА MACEDONIA	(02) 20 50 319	2 години 2 years	ГРУП СЕБ БЪЛГАРИЈА ЕООД бул. България 81 В, ет. 5 1404 София
MALAYSIA	603 7802 3000	2 years	GRUPE SEB MALAYSIA SDN. BHD Unit No. 402-403, Level 4, Uptown 2, No. 2, Jalan SS21/37, Damansara Uptown, 47400, Petaling Jaya, Selangor D.E Malaysia
MEXICO	(01800) 112 8325	1 año 1 year	Groupe SEB México, S.A. DE C.V. Calle Goldsmith 38-401, Polanco Ciudad de México C.P. 11560, México
MOLDOVA	22 929249	2 роки 2 years	ТОВ «Груп СЕБ Україна» 02121, Харківське шосе, 201-203, 3 поверх, Київ, Україна
NEDERLAND The Netherlands	0318 58 24 24	2 jaar 2 years	GRUPE SEB NEDERLAND B.V. De Schutterij 27 3905 PK Veenendaal
NEW ZEALAND	0800 700 711	1 year	GRUPE SEB NEW ZEALAND PO Box 17 – 298, Greenlane, 1546 Auckland New Zealand
NORGE NORWAY	815 09 567	2 år 2 years	GRUPE SEB NORDIC AS Tempovej 27 2750 Ballerup
عمان سلطنة OMAN	24703471	1 year	www.tefal-me.com
POLSKA POLAND	801 300 420 koszt jak za połączenie lokalne	2 lata 2 years	Groupe SEB Polska Sp. z o.o. Gdański Business Center II D ul. Inflancka 4C 00-189 Warsaw
PORTUGAL	808 284 735	2 anos 2 years	GRUPE SEB IBÉRICA SA Urb. da Matinha Rua Projectada à Rua 3 Bloco1 - 3º B/D 1950 - 327 Lisboa

قطر QATAR	44485555	1 year	www.tefal-me.com
REPUBLIC OF IRELAND	01 677 4003	1 year	GROUPE SEB IRELAND Unit B3 Aerodrome Business Park, College Road, Rathcoole, Co. Dublin
ROMANIA	0 21 316 87 84	2 ani 2 years	GROUPE SEB ROMANIA Str. Ermil Pangratti nr. 13 011881 București
РОССИЯ RUSSIA	495 213 32 30	2 года 2 years	ЗАО «Группа СЕБ-Восток», 125171, Москва, Ленинградское шоссе, д. 16А, стр. 3
السعودية العربية المملكة SAUDI ARABIA	920023701	2 years	www.tefal-me.com
SRBIJA SERBIA	060 0 732 000	2 godine 2 years	SEB Developpement Đorđa Stanojevića 11b 11070 Novi Beograd
SINGAPORE	6550 8900	2 years	GROUPE SEB SINGAPORE Pty Ltd. 59 Jalan Pemipin, #04-01/02 L&Y Building Singapore 577218
SLOVENSKO SLOVAKIA	232 199 930	2 roky 2 years	GROUPE SEB Slovensko, spol. s r.o. Cesta na Senec 2/A 821 04 Bratislava
SLOVENIJA SLOVENIA	02 234 94 90	2 leti 2 years	SEB d.o.o. Gregorčičeva ulica 6 2000 MARIBOR
SOUTH AFRICA	www.tefal.co.za	1 year	www.tefal.co.za
ESPAÑA SPAIN	902 31 24 00	2 años 2 years	GROUPE SEB IBÉRICA S.A. C/ Almagóvers, 119-123, Complejo Ecourban 08018 Barcelona
SVERIGE SWEDEN	08 594 213 30	2 år 2 years	Tefal Sverige, Löfströms allé 5, 172 66 Sundbyberg
SUISSE SCHWEIZ SWITZERLAND	044 837 18 40	2 ans 2 Jahre 2 years	GROUPE SEB SCHWEIZ GmbH Thurgauerstrasse 105 8152 Glattpark
ประเทศไทย THAILAND	02 769 7477	2 years	GROUPE SEB THAILAND 2034/66 Italthai Tower, 14th Floor, n° 14-02, New Phetchburi Road, Bangkapi, Huaykwang, Bangkok, 10320
TÜRKIYE TURKEY	444 40 50	2 YIL 2 years	GROUPE SEB ISTANBUL AS Dereboyu Cd. Bilim Sk. Sun Plaza No:5 K:2 Maslak 34398 Istanbul
المملكة العربية الامارات UAE	8002272	1 year	www.tefal-me.com
Україна UKRAINE	044 300 13 04	2 роки 2 years	ТОВ «Груп СЕБ Україна» 02121, Харківське шосе, 201-203, 3 поверх, Київ, Україна

UNITED KINGDOM	0345 602 1454	1 year	GRUPE SEB UK LTD Riverside House, Riverside Walk Windsor, Berkshire, SL4 1NA
U.S.A.	800-395-8325	1 year	GRUPE SEB USA 2121 Eden Road Millville, NJ 08332
VENEZUELA	0800-7268724	2 años 2 years	GRUPE SEB VENEZUELA Av Eugenio Mendoza, Centro Letonia, Torre ING Bank, Piso 15, Ofc 155 Urb. La Castellana, Caracas

12/10/2016

INTERNATIONAL GUARANTEE

Date of purchase / Date d'achat / Fecha de compra / Købsdato / Ostopäivä / Kjøpsdato / Inköpsdatum / Ostukuupäev / Pirkuma datums / Įsigijimo data / Data zakupu / Datum izročitve blaga / Datum kupovine / Vásárlás dátuma / Data achiziției / Дата на закупуване / Дата продажы / Цішдшырш ор. / Дата продажы / Сатылган күні / 購入日 / วันที่ซื้อ / 구입일자 / Датум на купување :

Product reference / Référence produit / Referencia del producto / Referencenummer / Tuotenumero / Artikelnummer / Produktreferens / Toote viitenumber / Produkta atsauces numurs / Gaminio numeris / Referenca produktu / Oznaka proizvoda / Tip aparata / Készülék típusa / Cod produs / Модел / Модель / Униці / Модель / Υλιци / 製品リファレンス番号 / รุ่นผลิตภัณฑ์ / 제품명 / Податоци за производител :

Retailer name and address / Nom et adresse du revendeur / Nombre y dirección del minorista / Forhandler navn & adresse / Jälleenmyyjän nimi ja osoite / Forhandler navn og adresse / Återförsäljarens namn och adress / Müüja kauplus ja aadress / Veikala nosaukums un adrese / Parduotuvės pavadinimas ir adresas / Nazwa i adres sprzedawcy /

Distributor stamp / Cachet / Sello del distribuidor / Forhandler stempel / Jälleenmyyjän leima / Forhandler stempel / Återförsäljarens stämpel / Tempel / Žimogs / Antspaudas / Pieczęć sprzedawcy / Pečat distributera / Pečat trgovine / Forgalalmazó pecsétje / Ștampila vânzătorului / Печат на търговския обект / Печатка продавця / Цішр. / Печат продавця / Сатушының мөрі / 販売店印 / ตราประทับของห้าง/วันที่ซื้อ / 소매점 직인 / Печат на дистрибутор :

NC00145862