



MARQUE: MOULINEX

REFERENCE: DJ300110





















CODIC: 4005694



- FR p. 1
- NL p. 1
- DE p. 2
- EN p. 2
- ES p. 3
- PT p. 3
- IT p. 4
- EL p. 4
- AR p. 5
- FA p. 5
- RU p. 6
- UK p. 6
- KK p. 7



- FR
- NL
- DE
- EN
- ES
- PT
- IT
- EL
- AR
- FA
- RU
- UK
- KK

| |  |  |
|---|---|---|
|  | 100g | 6  |
|  | 80/100g | 5  |
|  | 100g | 8  |
|  | 15g | 5  |
|  | 50g | 15s |
|  | 40g | 8  |
|  | 40g | 15s |
|  | 20g | 10s |
|  | 80/100g | 10s |
|  | 200g | 20s |
|  | 200g | 20s |
|  | 2  | 5  |

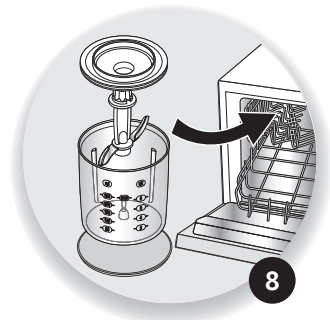
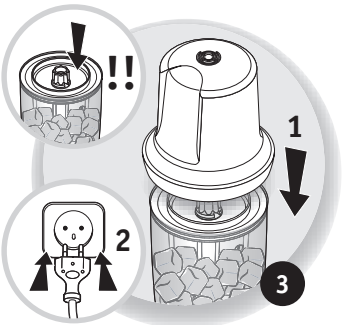
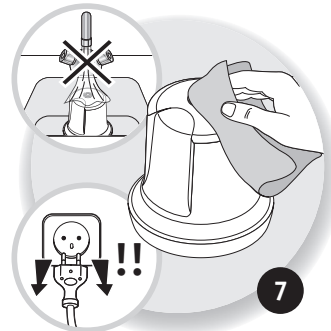
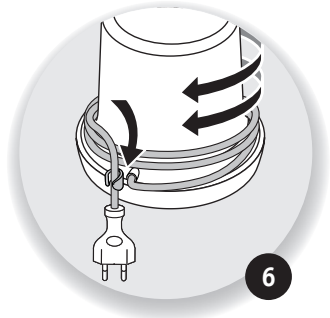
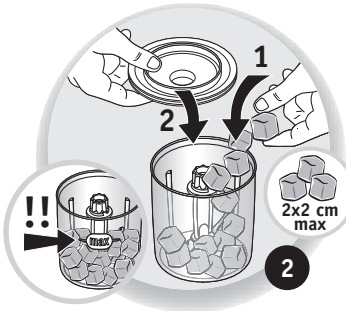
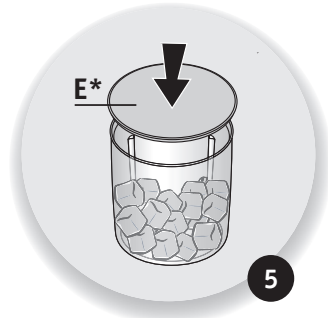
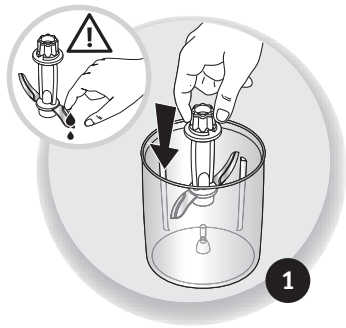
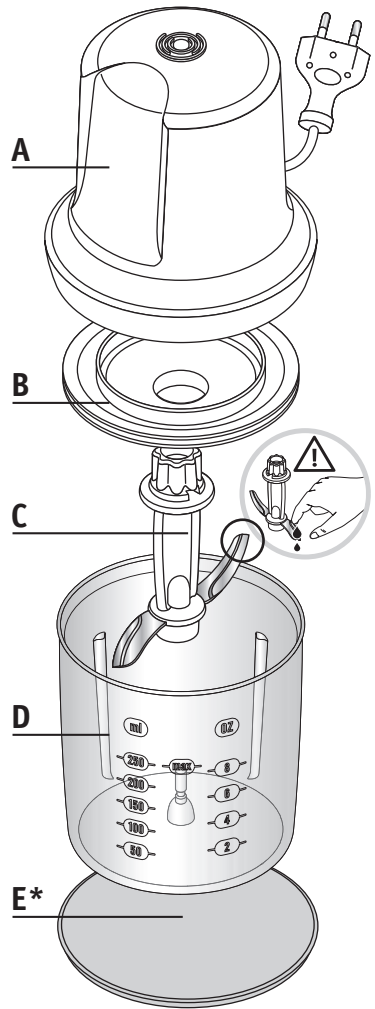

DESCRIPTION

A - Bloc moteur

B - Coupelle d'étanchéité

C - Couteau

D - Bol en plastique

E* - Base antidérapante et couvercle
(selon modèle)

UTILISATION (cf. fig.1 à fig.5)

CONSEILS D'UTILISATION

Manipulez le couteau avec précaution car les lames sont très coupantes.

Ne faites pas tourner l'appareil à vide.

Préparations semi-liquides : ne pas dépasser le niveau maxi du bol. Conseils pour obtenir de bons résultats : Travaillez en impulsions. Si les morceaux d'aliments restent collés sur la paroi du bol (jambon, oignons...), décollez les morceaux à l'aide d'une spatule, répartissez-les dans le bol et effectuez 2 ou 3 impulsions supplémentaires.

RANGEMENT DU CORDON (cf. fig.6)

NETTOYAGE DE L'APPAREIL (cf. fig.7 à fig.8)